

167. Jenson, P., [*Klinkerfues, W.*]. Jan. 15.

Hygrometers.—The scale, which consists of an arc of about 40° divided into one hundred equal parts, is attached to the end of a rod *s*, which has a bifilar suspension consisting of two pairs of hygroscopic bodies, such as human hairs *f, f'*, attached to hooks *i, i', j, j'*, Fig. 5. These hairs are also attached to hooks on nuts *m, n*, which may be adjusted by right and left handed screws *M*. The bracket carrying the bottom screw and nuts may be adjusted by a rack *B* and pinion *s*, or by a screw or other means. The upper nuts are supported on a gallows frame *I* connected to a temperature-compensating arrangement. The scale is read through a hole in the case *H*; or, if the case is of glass, the scale is read by a mark on the case. For adjustment, the case *H* is closed by a stopper *H'* and the moisture inside is absorbed by calcium chloride; the instrument is then adjusted by the screws *M* and pinion *S* until it reads zero.

241. Furrell, E. W., [*Browne, J.*]. Jan. 21.

Stands, telescopic.
 Relates to telescopic stands for suspending maps and charts, blackboards, &c. In the arrangement shown in Fig. 1, the map &c. is hung by hooks *f* from bars *d*, which may slide outwards by means of rings *e* on a cross-bar *c* to extend the width of the stand. By applying clips to the supports *f*, drawings, tracings, photographs, and other illustrations may be displayed. The maps &c., when not in use, are rolled up and placed on hooks *o* carried by a frame *p*. The cross-bar is attached to a bar or tube *b* provided at the lower end with a block *h*, Figs. 1 and 2, working in a slot *x* in the stand *a*. A pin projecting from the block *h* carries a washer *b'*, Fig. 2,

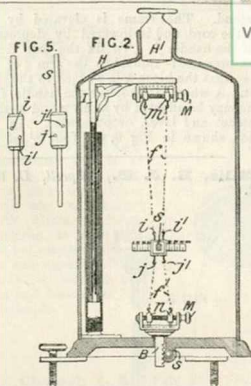
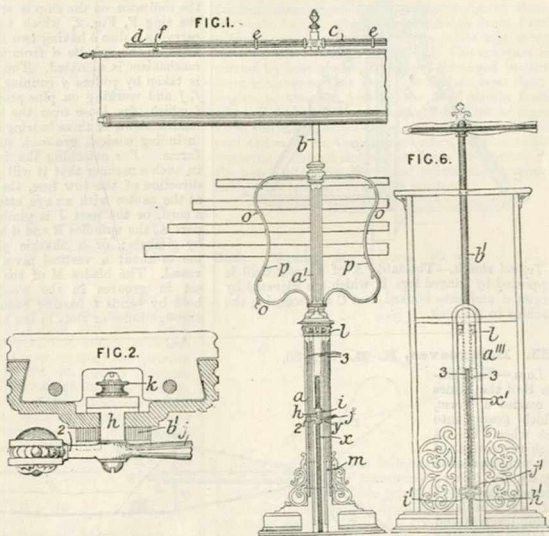

which is provided with a projection working in connection with a wedge-shaped recess formed in a handle *j*. The block also carries a pulley *k* to receive a weighted cord *3* which passes over pulleys *l*

on the stand. The frame is elevated by the weight on the cord, and is lowered by depressing the arm of the handle *j*. To fix the map &c. at any height, pressure is applied to the arm 2 of the handle *j*, so that the block *h* is wedged to the sides of the slot. A wheel may replace the handle *j*, or the locking may be effected by a screw and washer, or by a ratchet and lever, or otherwise. In the modification shown in Fig. 6, the foot *h* of the

standard *h* works in a slot *x* in the stand *a*¹¹. A recess in the block *h* contains a stud carrying a washer *l* to which a handle *j* is secured. The inner face of the washer has two wedge-shaped pieces which lie in the slot *x* when the standard *h* is free to slide up and down. The standard is locked by turning the handle *j* so that the wedges, by acting against the front edges of the slot *x*, clamp the feet.

246. Mills, B. J. B., [Siprell, D. W.].
Jan. 22.

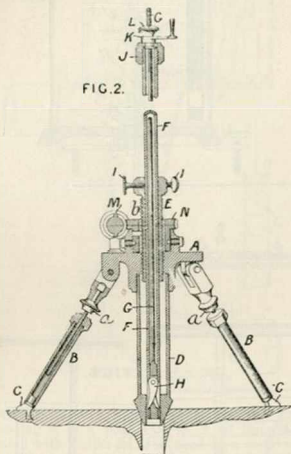

Tripod stands.—The table A of a rock drill is supported by hinged legs B which are adjusted by screws *a* and have hooked feet C for securing the machine to the rock.

319. Reynolds, W. F. Jan. 27.

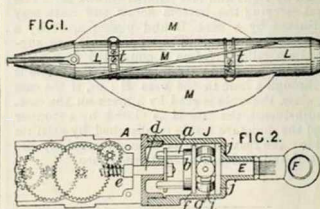

Logs.—The tow line connecting the rotator to the indicator on the ship is attached by a hook to the ring F, Fig. 2, which turns the spindle E carrying a disc *b* having two lugs *a* engaging with arms on the spindle *d* from which the indicating-mechanism is actuated. The pull of the tow line is taken by rollers *g* running between two plates *f*, *j* and working on pins projecting from a collar *i* which fits loose over the spindle E. Several modifications of these bearing-rollers are described, including conical, grooved, stepped, and rounded forms. For attaching the indicator to the ship in such a manner that it will adjust itself to the direction of the tow line, the case A is provided at the centre with an eye attached to the ship by a cord, or the part J is gimballed on to the front part A, the spindles E and *d* being also connected by gimbals; or a shackle pivoted to the case moves about a vertical pivot in the rail of the vessel. The blades M of the rotator, Fig. 1, are set in grooves in the woolen cylinder L and held by bands *t* passing round the cylinder and through holes or slots in the blades.

353. Hargreaves, H. E. Jan. 30.

Logs.—The spindle B of the blades C carries a worm, which gears into the wheel E. At each revolution of this wheel, a stud G upon it bears against the end I of an insulated spring lever H and so closes an electric circuit, the current passing through the wires O, P which

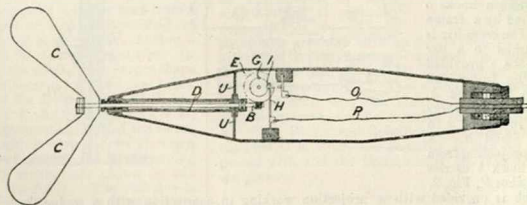

serve as a core for the towing-line. At each closure of the circuit, a mark is made on a clock-work-driven strip in the recording-apparatus. The spindle B is passed through a tube D secured to a diaphragm U which carries a thrust bearing for the spindle.

523. Laslett, T. N. Feb. 12.

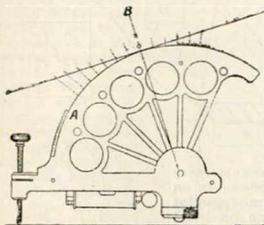

Telemeters; altitudes, linear, measuring.—

An instrument for measuring heights and distances consists of a segmental plate A, which may be set in a horizontal or a vertical position on screw feet, and carries at the centre a pivoted index arm B, which reads against a scale on the segment and is fitted with a telescope D and a mirror E, the latter being set at 45° to the line of sight of the telescope. To measure the height of an object, the instrument is placed in a vertical position and the index is turned by a rack and pinion until the reflection of the top of the object coincides with a needle point in the telescope; the distance of the object being known, its height is given by the product of the distance and the scale reading. In measuring the distance of the object, the instrument is used in a horizontal position and readings are taken from the ends of a known base line.

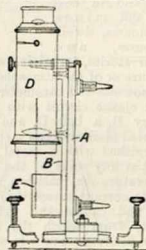

597. Sinclair, J. Feb. 18.

Face-protectors.—A face shield or respirator for use in the presence of noxious gases, smoke, &c. is provided with a filtering-apparatus. A filter A, described in Specification No. 2393, A.D. 1872, containing layers of cotton, wool,

charcoal, quicklime, or other absorbent of carbonic-acid gas, is fitted to a face-piece B of vulcanized sheet rubber which fits the face of the wearer in an airtight manner. A cavity C is formed for the nose and communicates with a space C' so that the wearer may breathe through the mouth or nostrils. Glass eye-pieces or goggles D are also fitted, but may be omitted when unnecessary. The whole is secured by straps and buckles, or by elastic bands.

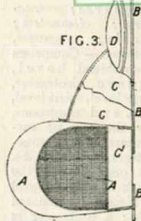

659. Chomel, I. A. Feb. 23. [*Provisional protection only.*]

Compasses, magnetic.—A self-levelling suspension for compasses consists of a jointed frame of three members, two of which are suspended from fixed points by universal or other free joints and carry between them the third member. The compass is carried by bearings or trunnions arranged on the third member so that their centre line is at right-angles to the line joining the fixed points from which the whole frame is suspended. One or more arms projecting downwards are fixed to the compass and carry at their lower ends a friction roller engaging a curved slot struck from the centre of the line joining the two fixed points, the compass being thus retained in a level position.

689. Beck, J., [Queen & Co., J. W.] Feb. 25.

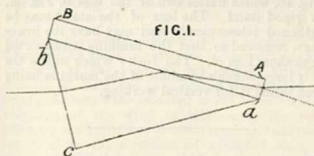

Spectroscopes; optical instruments.—Relates to a solid glass or other transparent prism, or to a hollow carbon-bisulphide prism, so constructed that the incident ray and the mean emergent ray are in the same straight line. An iron, brass, or other framework has a crown-glass plate A B, Fig. 1, cemented to the side a b, the face A a of which is polished and the face A B ground rough or covered. A thin glass plate is cemented to the side b c of the framework and the side a c is closed.

890. **Ascough, W.** Feb. 25. [*Provisional protection only.*]

Squares; protractors; clinometers; levels; compasses, drawing.—Comprises a combined bevel, square, protractor, slope level, spirit level, rule, and compasses, for the use of carpenters, joiners, stonecutters, machinists, &c. At one end of the stock of a spirit level is hinged a graduated rule; a protractor is also mounted on the same pivot and attached to the rule by a thumb-screw. A mark or line on a projection from the rule acts as a sight in conjunction with another sight let into the stock. The end of the rule is pointed, and a movable point is attached to the opposite end of the stock to form a pair of compasses.

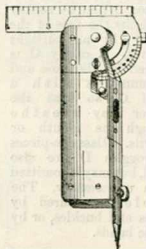

900. **Ellis, W.** March 11.

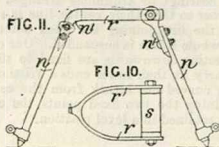

Tripod stands.—A universal joint or strap is secured to the cradle of a machine for boring out rock &c. and receives within it the horizontal shaft *s*, Fig. 10, which unites two of the legs *n*, Fig. 11, of a tripod stand. The legs of the stand may be lengthened telescopically and may have the lower parts *n* removed so that the machine is supported on the short legs *n'*. The fork *r* which unites the legs is large enough to admit of the machine being placed inside it for vertical working.

937. **Morgan-Brown, W.**, [*Hermages, J. H.*]. March 13. [*Provisional protection only.*]

Tripod stands.—The head of a tripod consisting of a metal disc is provided with three horizontal pins and three vertical wings to which the legs are jointed, and the legs are so shaped that, when closed, they form a complete circle. A wire having a suspended weight passes through a screw by which a camera is secured to the head and

through the disc to impart rigidity to the stand. The knob of the screw for securing the camera to the head is used, when the camera is dismantled, as the knob of a walking-stick.

945. **Bagot, A. C.** March 13.

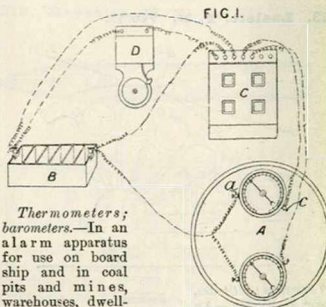

Thermometers; barometers.—In an alarm apparatus for use on board ship and in coal pits and mines, warehouses, dwellings, and conservatories, for giving warning of rise of temperature or of the atmospheric pressure, a metallic thermometer and barometer are connected in series in an elastic circuit with a Leclanché or other battery *B*, a bell *D*, and an indicator *C*. The insulated binding-screw *c* on the thermometer &c. is furnished with a metal projection which may be set at any point of the dial, so that, when the temperature &c. reaches a predetermined point, an electric current passes through the circuit, rings a bell, and causes the indicator to denote the locality from which the alarm was sent. The second binding-screw *a* is connected to the pointer of the thermometer or barometer.

990. **Moore, B. T.** March 17.

Current indicators.—For determining the direction of deep-sea and other currents, a magnetic needle, moving over a compass card contained in a spherical shell *a* of brass or the like, is fixed in position by clockwork when the instrument sets in the direction of the current. The shell, which is made in two parts, has a pointed cap *d* screwed to one side, and at the opposite side has a tail *b* consisting of a frustum of a cone with four blades. The instrument is suspended by two pivots from a shackle having a swivel for the attachment of a cord. The needle and clockwork are contained in a cylinder *g*, supported on gimbals inside the shell, and provided with a glass cover *k* against which the needle can be pressed by a lever *n* actuated by another lever *m*. The clockwork



consists of a spring o driving a train of wheels o^1 , o^2 , o^3 , o^4 , a regulating-fly p , and also a time-wheel q having a small hole to receive the end of a rod t , forced into it by a spring t^1 when the zero of the wheel q comes opposite a pointer. This movement of the rod t depresses the lever m and fixes the needle. The time-wheel is adjusted to make one revolution in one hour, but may be set to fix the magnet after any lapse of time up to one hour. For this purpose, the pinion driving the wheel q is made fast or loose on its spindle by a finger-nut. When loose, the time-wheel is turned round, the spring t^1 being held back by means of an arm attached to the rod t . The parts of the shell and the cap d are screwed up tightly by a spanner, the stops of which are inserted in the holes a^2 , and a key inserted in the hole d^1 . In some cases, an hour

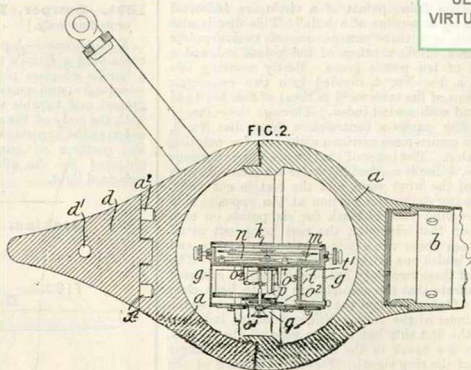

glass &c. may be used instead of the clockwork. The instrument may be used in combination with the current meter described in Specification No. 3939, A. D. 1873.

998. **Abel, C. D.**, [*Fayol, H.*]. March 18.

Eye-protectors.—Eye-protectors, for use in mines or in suffocating atmospheres or under water, are shown in Fig. 3. They consist of lenses exactly fitting the cavities between the eyes and nose.

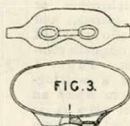

1012. **Dixwell, G. B.** March 19.

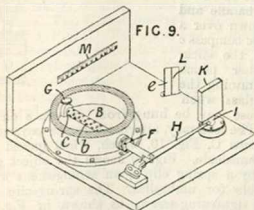

Pyrometers for use in steam-engine cylinders. A thin metallic tube B , open at the end c and having a number of holes b , is fixed to the cylinder head by a screw G and passes through a stuffing-box F ,

and is connected to a lever H , which turns a short vertical spindle I carrying a mirror K . A beam of light, from a lamp or other source, passing through a vertical slit e in a screen L is reflected from the mirror upon a graduated scale M . A graduated scale, with a vernier, may be used in connection with the spindle, instead of or in addition to the scale M , and the spindle may have an arm to operate an electric alarm bell at a rise or fall of temperature beyond the fixed amounts.

1113. **Gray, J. M.** March 27. [*Provisional protection only.*]

Course indicators.—Relates to an apparatus for mechanically solving problems in connection with the rule of the road at sea, which apparatus consists of dials and pointers, so constructed and arranged that, when one dial is set to indicate the direction of the wind in relation to the vessel whereon the apparatus is being used, and another is set to show the direction of a second ship, the apparatus will then show which vessel has to keep clear of the other, and will also indicate the possible courses of either vessel. In one arrangement, there are four discs or dials. No. 1 is a compass card upon a centre-piece, and projects beyond the circumference of a casing, which is formed by disc No. 2 together with a ring at the circumference and a back. Disc No. 2 is marked with "head, stern, beam, port, and starboard," and intermediate points. Disc No. 3 is "divided into two concentric portions of about equal width, and two sets of

"divisions being points of a circle are indicated each by an outline of a hull." This disc is also divided into three sectors, one of twelve points coloured black, another of ten points red, and a third of ten points green. Partly covering this disc is disc No. 4, divided into two concentric portions of the same radii as those of disc No. 3 and marked with a wind index. Through the centre of this disc passes a centre-piece from disc No. 3, which centre-piece carries a sight arm for pointing to a ship. The inner of the two concentric portions of No. 4 disc is marked black for six points on each side of the wind vane, and the rest is cut away. The outer concentric portion at the opposite side of the wind vane is black for six points on each side of that diameter, the rest being cut away. Between these concentric portions is a ring, and there is also one at the periphery of the disc. The first of these two rings has one semicircle coloured to indicate that the second ship has to keep clear of the first, and when the sight arm points over the remainder of the ring a different colour indicates that the first ship has to take care of the second. There is a break in the last-mentioned or danger part of the ring signal. Through a portion of the arc the danger ring is transferred to the circumference of the disc just inside the general inner line of disc No. 2, which has a projection broad enough to cover the transferred or outer danger mark of disc No. 4. When the position of the seen light and the direction of the wind indicated by their respective parts are relatively such that there is little chance of the vessels coming near each other, the transferred danger mark will be hidden by the projection of disc No. 2. Hull outlines are marked on disc No. 4 to indicate the possible courses of the two ships. The apparatus may be modified to show only which ship has to keep clear without indicating the relative positions of the two ships. In some cases, the sight arm is rearwardly extended and jointed to a hull skeleton to represent the position of the vessel. The discs or dies of the instruments may be constructed of glass &c. and illuminated at night.

1249. **Johnson, J. H.**, [*Hastings & Johnson*].
April 6.

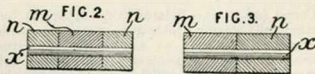

Scales.—To economize the ivory used in the manufacture of scales and rules, narrow strips are joined together, or are joined with wood, hard rubber, or ebony. In the latter case, the ivory is placed at the side where there is most wear. With a four-fold rule, the outer sections are formed of three pieces *n*, *m*, *n*, shown in transverse section in Fig. 2, held together by rivets *x* and a metal tip. The middle section consists of two pieces *m*, *n*, Fig. 3, both of ivory, or the outer one *n* may be of ivory and the inner one *m* of wood &c. When strips, other than ivory are used, they are preferably combined with boxwood.

1331. **Cowper, R.** April 13. [*Provisional protection only.*]

Kaleidoscopes.—A polarizer is used, the eye-piece containing a Nicol's prism, a tourmaline plate, or a bundle of glass plates, &c. The cell contains selenite &c., and consists of two plates of glass, one ground and capable of turning independently or with the body of the apparatus. The light, before entering the apparatus, passes through a polarizer, and patterns of pure natural colours are thus obtained by the effect of the selenite on the polarized light.

1379. **Hosking, W. L.** April 15.

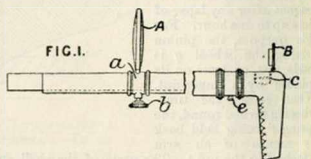

Telescopes and field glasses; compasses, magnetic.—Relates to walking-sticks, umbrellas, whips, &c. which are fitted to serve as telescopes or field glasses, and are also provided with magnetic compasses. Fig. 1

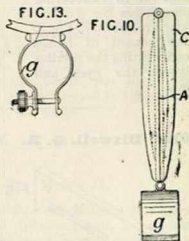
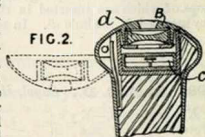

1 shows a walking-stick to which an object glass *A* is attached by a clamp *a*, the screw *b* of which may enter a guiding-groove. The eye-piece *B* is hinged to the stick at the handle and folds down over a magnetic compass *c* let into the stick. A leather pouch for containing the object glass when not in use may be hung from an eye *e* on the stick. The lens may, alternatively, be covered by hinged caps *C*, Fig. 10, which, when opened out, form a sunshade. Fig. 10 shows the object glass carried by a spring clip *g*, an arrangement which is suitable for umbrellas. The spring clip may have a tightening-screw, as shown in Fig. 13. Fig. 2 shows an eye-piece *B* and compass *c* let into the head of the cane.

1415. **Atkin, R.** April 19. [*Provisional protection only.*]

Compasses, magnetic.—A standard compass is placed out of the influence of local attraction on a bracket fixed to the funnel of the steamer, which is made of copper or other non-magnetic material. The funnel stays may be used as ladders to reach the compass. Or the standard compass may be placed on a copper pillar, or on a spar projecting from the head of a pair of shears which swing and project from the stern of the vessel. The binnacle and other parts of the compass, except the needle, are made of glass.

1424. **Diplock, S.** April 19.

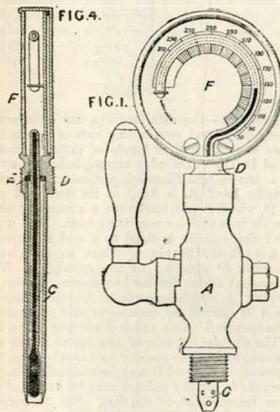

Thermometers for ascertaining the temperature in pipes, boilers, or other closed vessels are enclosed in a tube C, Fig. 4, and inserted through the way of a cock A, Fig. 1. The upper end of the thermometer is bent into a circular arc, and is contained in a case having a glass front F and socket D, which receives the upper end of the tube C and is screwed to the casing of the cock. Packing E closes the upper end of the tube C.

1548. **Jewitt, H.**, [*Craighead, H.*]. April 27.

Reflectors.—Relates to mirrors or reflectors for lamps and other like purposes. Fig. 1 shows a pair of V-shaped reflectors D, D' hinged on the vertical branches of arms C so that they can be turned into any position. The reflectors may be arranged, as shown, to reflect the light equally in opposite directions, or they may be turned to bring

their edges together to throw the light in any direction; or they may be otherwise arranged. The reflectors may be used singly and in a reversed position. The sides or wings of the reflectors may

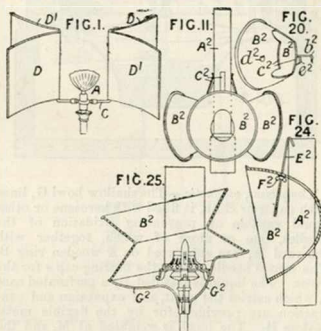

be flat or concave. Pyramidal, conical, parabolic, or other shaped reflectors may be used singly or arranged in sets of two or more around the chimney or glass of a lamp &c. Fig. 11 shows three parabolic reflectors B² fitted around a lamp chimney A² and held in position by spring fingers C². They may be inclined at any angle. In other arrangements, the apices of the reflectors are cut away to form lips c², Fig. 20, to fit around the lamp &c., and they are connected by hooks b² engaging eyes d², which hooks are formed with loops e² to render them elastic. Fig. 25 shows a double reflector B² supported by wire or sheet-metal arms G². Fig. 24 shows a parabolic reflector B² fitted on a chimney A² by means of a hook E² and nut F². The chimney may be passed through only one opening in the reflector, which is then supported in a nearly horizontal position to throw the light downwards.

1571. **Dadswell, J.** April 29. [*Provisional protection only.*]

Pantographs.—Two serrated wheels are connected by a spindle supporting above it a bar or rod. This bar has two bearings on its inner side, from which project two swivelling rods terminating in similar bearings connected to a second bar. The second bar will always be parallel to the bar first-mentioned, and is provided with sliding blocks which form holders for scribes, pencils, or pens. A blank sheet of paper being placed on the left of the operator, and the manuscript, or other document to be copied, on his right, the apparatus is placed so that the scribe is over the original, and the pencil over the blank paper. As the scribe is passed over the manuscript, the pencil copies it on the blank paper.



1577. Baker, D. April 29.

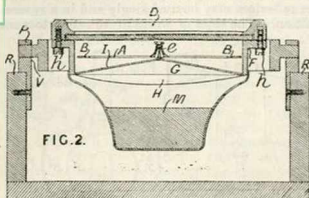

Compasses, magnetic.—The shallow bowl G, lined with paper or cloth, is filled with kerosene or other liquid capable of preventing oxidation of the needles, one or more of which, together with the card A, are supported on a wooden ring B. The centre needle carries the bearing-cap e for the pivot. The liquid is steadied by a perforated cone I, which carries the pivot, and expansion and contraction are provided for by the flexible metal bottom H. The bowl is weighted at M, and the cover D is held in place by screws h passing upwards through the flange F. The outer gimbals are placed in the fore and aft line of the ship. A cover is held on the case R by projections P on the gimbal bearings V.

1825. Clark, A. M., [Lambert, C. L.].
May 17.

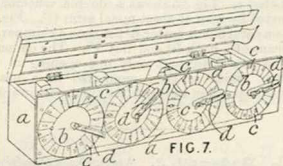

Actinometers.—The box a is provided with one or more dials b provided with ratchet teeth between which are holes c differently spaced. The index d has a spring latch which can be set to engage in particular holes. A strip of paper is wound on the axis of the index and "by moving forward the index the paper which has attained the tint indicated is caused as the index passes each notch to advance and expose another blank portion to be printed to form a new tint."

1832. Wood, R. J. May 18.

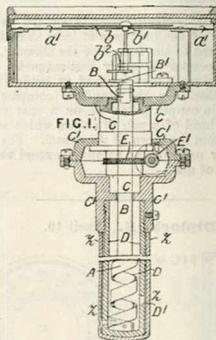

Pyrometers.—Consists, mainly, in constructing the expanding and contracting rods of pyrometers of two sheets, bars, or bands of different metals twisted in the form of a screw, helix, or scroll. Fig. 1 shows one form of pyrometer. A spiral bimetallic band A is fixed at its lower end in a tube D, which is provided with a protecting case z and with holes D' for admitting heat. The upper end of the spindle is fixed to a rod B provided with a crank b', the pin of which works in a slot in a crank b' attached to the spindle b'. This arrangement allows for the longitudinal motion of the spiral A, which imparts a circular motion to the rod B caused by expansion and contraction. On the spindle b' is an index b moving over a dial a'. The circular motion of the spiral A may also be transmitted to the pointer by a toothed segment and pinion, or the rod B may be connected directly to the axle b', or the pointer may be fixed and the motion transmitted to the dial. For the purpose of setting the instrument to zero, the case is attached to a piece C, which may be turned by a worm-wheel and screw E, E' in the piece c', to which the tube D is fixed.

1855. Morgan-Brown, W., [Shuette, O.].
May 21.

Photometers.—Pocket instruments for measuring the intensity of light are each constructed with a number of discs or sheets of partially-transparent material, which can be interposed between the eye and the light. Fig. 3 shows one form of apparatus. In a box b are formed a number of holes d arranged in a circle, behind which holes are a corresponding number of discs of paper a, parts of which are cut away in such a manner that opposite each successive hole d there will be an increasing number of thicknesses of paper from 1, 2, &c., up

to 20 or 60. At the back is a piece of ground glass *g*, and in each hole *d* is a piece of glass on which is a figure telling the number of thicknesses of paper discs or on the box *b*. The box revolves on an axis *b'* in a case *c* provided with a focussing-lens *f*. In using the instrument, it is directed to the light to be measured, and the box *b* turned round until the number that can only just be seen is in the field of view. The ratio that this number bears to the full number of discs is the ratio of intensity of the light to the standard light. Several modifications are described. In one, the lens *f* is placed in the centre of the case *c* and the axis *b'* is mounted eccentrically. In another form, shown in Fig. 8, paper bands *a* are placed on the circumference of the box *b'*, which is perforated with holes *d*, and the light is reflected along the axis of the case *c* by a mirror *n*. In another form, two cases, constructed as shown in Fig. 3, are joined together so as to form a sort of opera glass arrangement, the two boxes *b* being geared together.

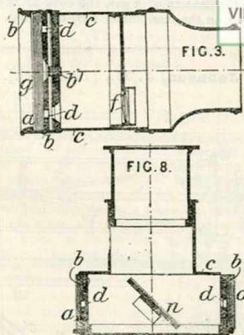

1872. Bablon, V. May 21.

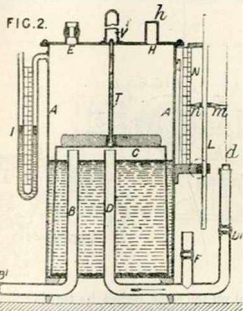

Photometers; specific-gravity estimating - apparatus. — Relates to an apparatus for measuring the illuminating power of gas according to the size of the flame, which apparatus can be used for showing the density of gas. A constant flow of gas at a definite pressure is obtained by the apparatus,

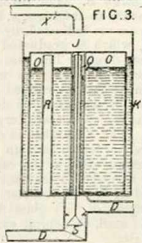

and the size of the flame obtained is taken as a

measure of the intensity. In one form of apparatus, the gas is delivered by the tube B, Fig. 2, into a weighted bell C which, on rising, drives the air out of the surrounding vessel A through the cock E. When the bell is full, the taps B' and E are closed and the tap D' of the burner pipe D is opened until the pressure of air in the receiver A, as shown by a manometer I, is at its specified point. Fresh air passes into the vessel A through a diaphragm *h* with an invariable orifice; the inflow of air and consequently the outflow of gas is thus constant. A rod T from the bell passes into a glass tube V and indicates the amount of gas in the bell which is made conical so that the pressure of gas due to the weight of the bell shall not vary. The bell C may be placed in an open vessel and connected to a second bell in a closed vessel. The height of the flame at the burner *d* is measured by a pointer *m, n* moved by a rack L over a scale N. When a fresh sample of gas is tested, it is run through the apparatus for some time, the gas passing out at the cock F. To bring the pressure to the same point without shifting the delivering-cock D', the apparatus, shown in Fig. 3, is fitted into the delivery tube D. It consists of a vessel J connected by a tube X to the air vessel A, Fig. 2, and containing a double floating bell O, Q connected to a conical valve S. The outside part *o* of the double floating bell is connected by a tube R to the atmosphere, and the inside Q, which is of the same cross-sectional area as the valve S, is connected to the delivery tube D. When the pressure in the air vessel falls to the fixed amount, the bell O, Q will fall and open the valve S. Other forms of the regulating-apparatus for producing a constant flow of gas at a definite pressure, are described. In one, the bell C is supported by a cord running over a drum moved by clockwork. In this case a dry meter may be used, the clockwork being connected to a weighted piston. A gas-meter fly may be used, either driven or controlled by clock-work. When the apparatus is used for

showing the density of a gas, the cock D^1 is opened and the gas allowed to escape at the orifice d , the indications on the manometer I being noted.

1910. Johnson, J. H., [Berdan, H.]. May 25.

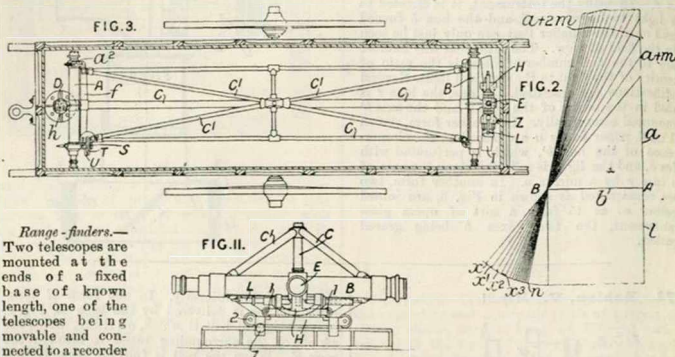

Range-finders.—Two telescopes are mounted at the ends of a fixed base of known length, one of the telescopes being movable and connected to a recorder which indicates at sight the distance or the degree of elevation, or both. In the diagram shown by Fig. 2, b represents the fixed base and a the minimum distance that can be measured; the distances $a+m$, $a+2m$, &c. are determined by measuring the arcs x , x' , x'' , &c. The two telescopes A, B, Fig. 3, are connected by a tubular frame C, C', so that, when B is moved to cause its cross-hairs to coincide with the object, the telescope A will have the same motion and the two will remain parallel. The central tube C of the frame moves in horizontal bearings D, E so that both telescopes are simultaneously elevated or depressed to the same extent. The bearing D is attached to a vertical pivot h , Fig. 6, and the bearing E is carried on a foot H mounted on rollers 2, Fig. 9, moving over an arc I; the two telescopes thus move round the same centre h and can be clamped by a screw Z. A fine adjustment for this motion is provided by a micrometer screw L, the bearing E being attached to the upper part of the foot H which can be moved on rollers 1 over the lower part, which is provided with the rollers 2 running on the arc I. The cross-hairs of the two telescopes are adjusted to the same horizontal line by screws k , Fig. 9, attached to the rear supporting-ring of the glass B, which screws move the glass vertically. The telescope A is mounted to move about a vertical axis a^1 placed at its forward end, and it is moved by means of a differential or micrometer screw S working through the transverse arm f of the main frame. In using the instrument, the cross-hairs of the glass B are brought on the object, and then the cross-hairs of the other glass A are

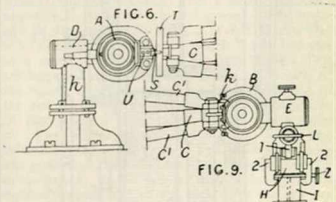

brought on the same object by turning the micrometer screw S. One revolution of the screw S corresponds to the arc x , n , Fig. 2, and subdivisions of this arc are indicated, by the pointer U, on the disc T, which is graduated so as to read off the distances direct. The disc may also be arranged to indicate elevation as well as distance. The instrument may be carried by hand, or it may be mounted on wheels to be drawn by a horse, or to be attached to an artillery caisson as shown in Fig. 3. The apparatus is contained in a case, the two ends of which turn up when in use to uncover the glasses. Below the case are legs which fold down for the instrument to rest horizontally. Instead of the micrometer screw S for measuring the angles of the glass A, a differential screw may be used, or a spiral surface, or a wedge, or an eccentric.



2013. Edwards, E. June 2.

Tripod stands.—

Fig. 7 shows a stand for a rock-drill. The cylinder *b* slides between parallel bars *a* connected by frames *c, d*. The lower frame *d* is formed with a socket to receive the tube *g*, in which slides the adjustable leg *h*; *f* is an additional socket in which the tube *g* is placed

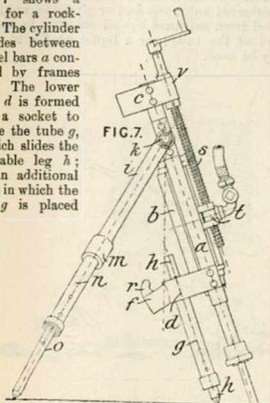

alongside the arms *i* carrying the bracket *e*, in which the other legs diverge. The arms *e, i* may be connected by stays. The frame *a* carrying the cylinder *b* can be swung outward and secured in position by means of the curved stay *e*.

2061. Bull, W. June 4. [Provisional protection only.]

Thermometers and pyrometers.—In order that the temperature in a brine-evaporating pan may be maintained nearly constant, a "bell thermometer," in which columns of mercury make and break contact with two platinum wires, is placed in the pan. The platinum wires are separately connected to the opposite poles of an electric battery, a bell being placed on the negative wire and another on the positive wire; the bells are separately operated when the temperature falls and when it rises beyond predetermined limits. A "bell-pyrometer," fitted with a rod carrying projections which make contact with the opposite poles of a battery, is similarly fitted to the furnace which heats the pan.

2147. Hans, M. L. P., and Hermery, H. A. H. June 11.

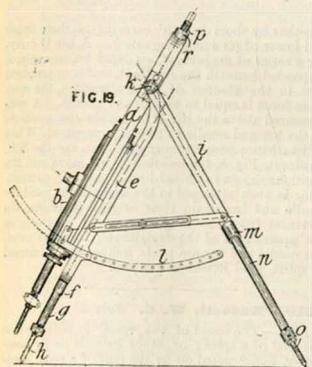

when the drill is to be used in a horizontal position. The front leg may, however, be pivoted to the frame, so that it can be adjusted at any angle. The back legs consist of a forked bracket *m* carried by bars *i* pivoted at *k*, tubes *n*, and adjustable bars *e*. The apparatus may be steadied by weights hung on the hook *r*. In the stand shown in Fig. 19, the front leg *g, h* is carried by a forked bracket *f*, the arms *e* of which are pivoted at *k*

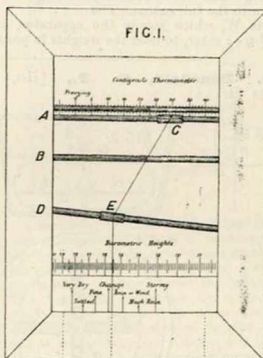

Barometers.—Barometric indications are obtained by arranging two thermometers, one containing air and the other liquid, horizontally one above the other, and joining the absolute zeros of the two instruments by a permanent straight line. A line drawn through the thermometric readings of the two instruments will intersect the zero line in a point which will be the same for all thermometric readings taken at a constant barometric pressure. The line through the readings of the liquid and air thermometers A, B, respectively, is

by means of a weighted string carried by a slider C and passing through an eye on the slider E of a rod D, which, if continued, passes through the absolute zeros of the thermometers. The vertical part of the string indicates the pressure on a graduated scale, as shown. The slider C may be arranged on the tube A, and the indicating-string may be replaced by a needle or other mechanical

index. A movable scale may be provided to allow of adjustment for different altitudes. The tube of the air thermometer is bent several times to form a number of horizontal limbs. The index consists of coloured sulphuric acid or glycerine, and is protected from moisture by oil inserted in the last bend of the tube; or a liquid unaffected by air may be used.

2287. Reynolds, G. H. June 23.

Tripod stands.—Two legs J of the tripod or a rock drill are mounted on squares on the spindle K, so that they move together. The third leg I turns on the spindle K, which can revolve in the frame body G. The parts have conical engaging-surfaces, and are locked, after adjustment, by screws L at the ends. The legs have double feet n^1, n^2 , to allow their positions to be reversed. The upper portion m of each leg is solid and the lower portion n tubular. The locking-screw o bears on a tapering flat on the part m , so that, if the screw is slackened, the leg does not suddenly shorten to the full extent. The weights W, which steady the apparatus, are made with grooves w, y into which the legs n and cross-bars z enter, to hold the weights in position.

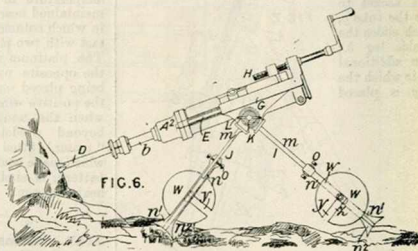

2309. Bousfield, G. T., [Hes, G.]. June 24.

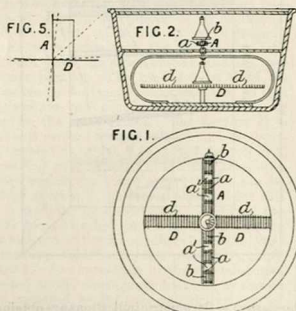

Compasses, magnetic.—Relates to means for detecting and compensating errors in ships' compasses due to local attraction, the arrangements being also applicable to compasses used in determining the angle of dip, land surveying, exploring, and mining. Figs. 1 and 2 show a plan and sectional elevation, respectively, of the compass. The needle A consists of two parallel bars a of aluminium or other non-magnetic material held

together by short bars a^1 carrying at their upper and lower edges small magnets b . A bar D carrying a series of magnets d , arranged transversely, is suspended beneath the needle A, and is so arranged that, in the absence of local attraction, the magnetic force is equal to that of the needle. A wire is secured above the bar D to enable the positions of the bar and needle to be easily compared. When a disturbance occurs in any quadrant, say the N.E. quadrant, Fig. 5, the needle and bar move into the positions shown in dotted lines. A steel compensator is then arranged in the acute angle until the needle and bar attain their original positions, the distances from the magnets varying inversely as the square root of the deviations. In some cases, the needle and bar are made hollow and immersed in spirit, as in Ritchie's compass.

2619. Russell, W. C. July 23.

Logs.—The speed of the vessel is indicated on the dial of a spring or other balance or dynamometer, Fig. 2, acted on by the pull of a rope towed behind. This rope S, Fig. 3, is weighted at T, and is connected by a line R with the eye C of a cross-bar B, the movements of which are controlled by two springs A. The bar B is connected by a link E with a straight or curved rack D for actuating the pinion F on the axis of the index. The axis also carries a toothed wheel H forming the first of a train of multiplying-wheels terminating in a regulating-fly N. The Provisional Specification also states that the index is provided with two pins



and is operated by an arm working between the pins, thus preventing vibratory motion due to waves.

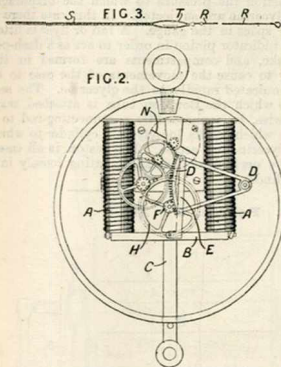

2622. Cooper, C. F. July 23. *Drawings to Specification.* [Provisional protection only.]

Sounding-apparatus.—An alarm is given when a towing-drag touches the bottom. The pull of the drag turns a wheel and sounds an alarm, discharges a pistol, or shows a red light. The depth can be fixed by knowing the length of the line and its inclination. The length of line is indicated on counting-wheels connected with the axis of the line-wheel, and the inclination by means of a pointer connected to the line and moving over a graduated disc. The wheel is held in position by a line passing through a brake. The wheel is so weighted that, if the drag line breaks, it turns back and signals that a new line is required. A scale of depths agreeing with the length of line and angles is provided.

2683. Hughes, W. C. July 29.

Dissolving-view apparatus.—Consists in placing the jets in three separate cylindrical or other shaped casings of brass, tin, iron, copper, silver, gun-metal, zinc, &c. each having an inner lining separate from the outer casing, which is perforated, as shown in Fig. 2, to allow the cold air to enter and cause the heated air to pass between the casing and the lining and escape through the chimney placed at the top of each casing. The casings are supported one above the other on separate cradle-pieces, and are held firm by set-screws, thus enabling the arrangement to be taken to pieces to form a bi-cylindrical apparatus; or by providing each casing with a separate foot they may be arranged side by side, or by removing all the cradle-pieces they may be arranged to form a single lantern. An opening is left at the lower part of the bottom casing, as shown in

Fig. 3, for the insertion of a lamp, if desired, and a flap H is hinged to the back end of each casing to block out the light. To prevent the

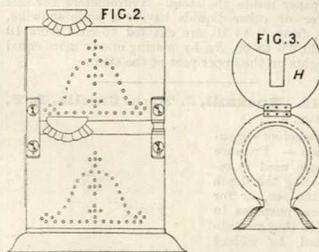

heat from being conducted to the points, a ring of deal or mahogany is fixed at the front of each casing.

2697. Young, F., Hudleston, B., and Crisp, H. July 30. [Provisional protection only.]

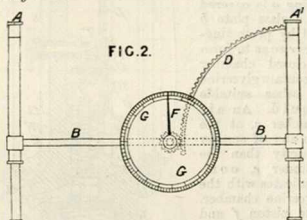

Telemeters; theodolites.—A telemeter, shown in plan in Fig. 2, consists of a telescope A' fixed to the bar B and movable telescope A' pivoted on the bar and provided with a toothed quadrant D for moving the pointer F over the indicating-dial G. The bar B is connected by a ball-and-socket joint to the tripod. In using the instrument, the object is first sighted by the telescope A, and afterwards by the telescope A', the movement of the latter causing the pointer to indicate the distance. In some cases, the quadrant is graduated and the dial omitted. The fixed telescope may be used as a theodolite.

2701. Hicks, J. J. July 30. *Drawings to Specification.*

Specific-gravity estimating-apparatus.—In order to render the graduations of glass hydrometers distinct and durable, the stem is made of enamel, opal, or other semi-transparent or opaque glass, the graduations being engraved and filled in with glass enamel, which is afterwards fused; or the graduations may be painted in a light colour on

dark stem and fixed by fusing. In another form, the graduations on the outside of a clear glass stem are made distinct by placing a tube or strip of paper inside the stem. Hydrometers for salt water or other liquids having a scale showing, say, from 0 to 10, are enabled to read from 10 to 20, 20 to 30, &c. by placing one or more equal weights on the upper part of the stem.

2742. Bucknill, J. T., and Casella, L. P.
Aug. 4.

Sounding apparatus. — Pressure gauges used in estimating the depth of the sea, or for other purposes in which they are subjected to violent shocks, are provided with dash-pot arrangements in order to prevent the indicator from moving too quickly. In the gauge shown, the front of the casing *a* is covered by a glass plate *b* and by protecting-bars *c* so as to form a closed chamber to contain glycerine or other suitable liquid. An air chamber *c*, at the top and of smaller capacity than the cylinder *e*, communicates with the glycerine chamber. The piston *f* and piston-rod *g* fit loosely into the cylinder *e*, and are moved by the action of the external pressure on the diaphragm *i* and spring *h*, so that the pinion *o* of the indicator *m* is turned by its engagement with a rack *n* on the rod *g*. The maximum indicator *p* is moved by the action of the indicator *m* on the projection *q*. The indicator *p* may be set back to zero by means of the pinions *r* and the rod *s*; the rod *s* may pass through the back, front, or sides of the casing *a*. The spring *w* which presses the piston *f* back is made of uniform steel wire. The dial *u* may be graduated to read pressures or depths of sea-water. In another gauge, a second weighted rack is applied to the pinion *o* at the side opposite to the rack *n*, in order that severe shocks may be better compensated for. Transverse plates may be fitted to the racks to prevent them from moving rapidly. A

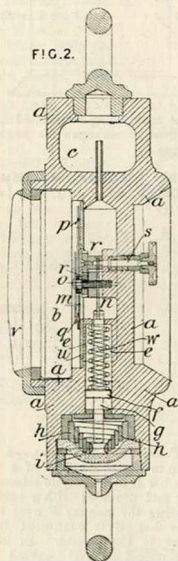

closed Bourdon tube is, in another form of gauge, attached to a toothed sector in gear with the pinion of the indicator, in order to indicate by its contraction the pressure to which the diaphragm and glycerine are subjected. In this case there is no air space in the gauge. A fan or flyer is fitted to the indicator pinion in order to act as a dash-pot or brake, and compartments are formed in the casing to cause the movements of the case to be communicated rapidly to the glycerine. The sector to which the Bourdon tube is attached may, otherwise, be connected by a connecting-rod to a piston which works loosely in a cylinder to which the glycerine has access. The piston, in all cases, may be perforated instead of fitting loosely into the cylinder.

2782. Pearce, W. Aug. 6.

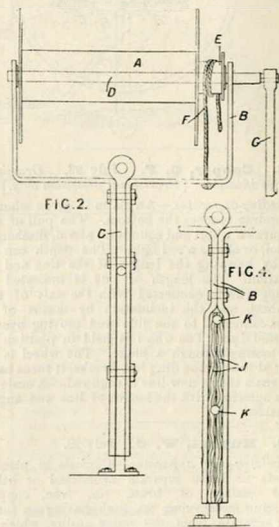

Logs.—Consists of a reel for drawing in the log. The reel *A*, Fig. 2, is carried in a light frame *B* capable of being easily fastened to the rail, bulwark, or stanchion *C* of the vessel; the log can then be hauled in by one man. The reel is fixed to the axle *D* which carries a cylinder *E*, round which passes the rope *F* acting as a brake. The winch handle *G* is made removable, or arranged to be put out of gear. A reel is placed on each side of the ship. Fig. 4 shows a reel frame bolted to the rails *K*. The rails are clasped by pieces of the framework *B*.

2948. Barlow, A. Aug. 21.

FIG. 1.

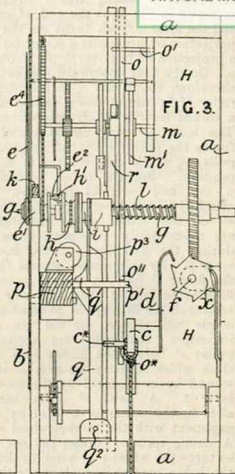
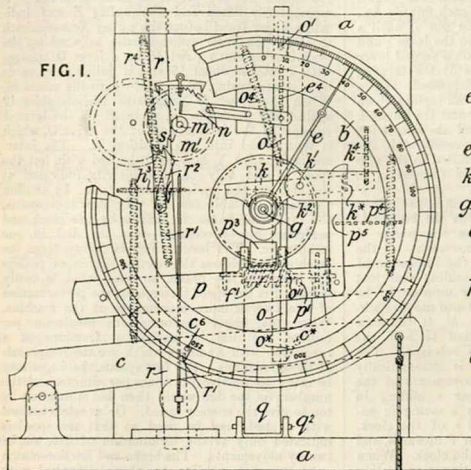

FIG. 3.

Logs.—Relates to apparatus for indicating the number of rotations or movements per minute &c. of shafts or other bodies. The apparatus may be applied to locomotives, ships' logs, or other bodies or measuring-machines for indicating miles &c. In one form of the apparatus, a pointer or finger *e*, Figs. 1 and 3, attached to a pulley *e*¹, moves over a dial *b* on the front of the framing *a*. The shaft *g* on which the pulley *e*¹ is loosely mounted carries a worm-wheel in gear with a worm *f*¹ on a spindle which carries also a ratchet-wheel *x*. The main or primary lever *c* is vibrated vertically from the machine the speed of which is to be indicated, and carries a spring hook or catch *d* which engages with and turns the wheel *x*, and consequently the shaft *g*. A sliding pulley *i* on the shaft *g* is forced by a spring *l* outwards against a loose pulley *h*, which is thus driven by friction. A pin *h*¹ on the pulley *h* bears against a pin *e*² on the pulley *e*¹ and turns the finger *e* in the direction of the rotation of the shaft *g*. Springs *e*¹, *h*² tend to turn the pulleys *e*¹, *h* back in the

FIG. 15.

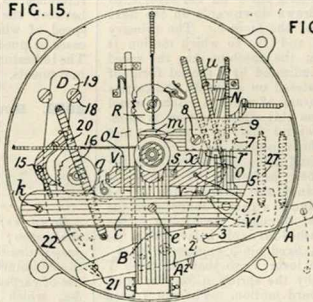
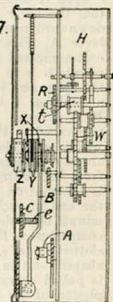

FIG. 17.



opposite direction to bear against a fixed stop, that is, to the zero position. Brake blocks *k*² on a lever *k*, centered on a pivot *k*¹, are pressed by a spring *k*³ against the pulley *e*¹ in order to maintain the finger *e* at its indication when the pin *h*¹ is withdrawn in the working of the apparatus from the pin *e*². The pin *h*¹ is automatically returned to the zero position at the end of each minute or other interval of time by the spring *h*³ on the withdrawal of the pulley *i* from the pulley *h*. A projection on the spindle *m* of the escapement-wheel *m*

of the clock mechanism in the compartment *H* presses a sliding arm *n* towards the right, as shown in Fig. 1, at the end of each minute &c., and the lever *o* then turns on the pin *o*¹ until a projection *o*² lies under a pin *c*² on the lever *c* and a projection *o*³ lies over a pin *p*¹ on a second lever *p*. On the next downward stroke of the lever *c*, therefore, the levers *o*, *p* are depressed, and a roller *p*² is carried down against an incline *q*¹ on a forked lever *q* which passes round the pulley *i*. The lever *q*, being moved round its centre *q*², forces the pulley *i* out of engagement with the pulley *h*, which then returns as stated to the zero position. Springs *o*⁴, *p*⁴ return the levers *o*, *p* to their original positions. A hook *p*³ attached to the lever *p* engages with a projection *k*² on the brake lever *k*, so that the brakes *k*² are momentarily withdrawn from the pulley *e*¹ during the first part of the movement of the lever *p*. By this means, should the indication of the finger *e*¹ for the minute preceding that just finished be greater than the new number to be indicated, the finger *e*¹ is released and moves backwards until stopped by the pin *h*¹ at the new indication; the brakes are applied to hold the pulley *e*¹ before the pulley *h* is released. The clock which actuates the arm *n* is automatically wound up as required by the movements of the lever *c*. A pawl *r*² on a bar *r* sliding in slots in the casing *a* is held by a spring in engagement with the ratchet-wheel *s* of the clock. A strong spring *r*⁴ draws the bar *r* upwards, and so turns the wheel *s* to wind up the clock. When the bar *r* reaches its highest position, a projection *r*¹ upon it comes under a pin *c*¹ on the lever *c*, so that the bar *r* is drawn downwards on the next downward motion of the lever *c*. The primary lever *A*, Figs. 15 and 17, to which motion is communicated from the machine &c., the speed of which is to be indicated by a second form of the apparatus, is centered on a pin *A*², and carries a catch-bar *L* by means of which a ratchet-wheel *R* is driven. From this wheel motion is communicated to the central shaft by a pinion *t* and wheel *w*. The three pulleys *X*, *Y*, *Z* are as already described, and drive the indicating-finger from the central shaft, as before. The brake *m* is centered on a pin *8*, and carries a pin *7*. At the end of each minute, a cam or tappet *g* on the minute-hand shaft of the clock mechanism in the compartment *H* pushes forwards a lever *V* in its slotted guides *o*. A fixed pin *s* engages in an L-shaped slot in the lever *V*, so that the lever *V* is pulled upwards by the spring *u* on the completion of its forward motion. The pin *j* then bears against the curved part *x* of a hanging lever *N*, and moves it forwards with the shoulder *2* under the pin *3* on the lever *A*, and with the projection *v* over the projection *v*¹ on another lever *c*, which is centered on a pin *k* and is normally held up by a spring *27*. On the next downward stroke of the lever *A*, the levers *N*, *c* are depressed, and a pin *e* on the lever *c* moves the forked lever *B* so that the pulleys *X*, *Y* are disengaged. By means of the pins *r*, *j* on the lever *N*, the lever *V* is returned to its original position. At the first part of the movement of the lever *c*, a hook-bar *5* pivoted to it engages

with the pin *7*, but is afterwards disengaged by the action of the pin *9*, so that the brake *m* is momentarily lifted and the pulley *Z* and indicating-finger freed before the pulley *Y* moves back to zero. In order automatically to wind up the clock mechanism, a pawl *15* on a lever *D* engages with a ratchet-wheel *16* and is pulled downwards by a strong spring *20* so as to turn the wheel *16*. When the lever *D* rests with the shoulder *19* against the guide-pin *18*, a pin *21* on the lever *A* engages in the bottom end of the lever *D*, which is then raised into the position *22*. The intermediate pulley *Y* may be dispensed with, but the speed would only be momentarily indicated at the end of the period, in this case. In another apparatus, suitable for use with slow movements, the indicating-finger is driven by the clock and performs one revolution over the dial in one minute &c. The lever which is driven from the machine &c. releases the friction clutch or pulleys and operates the brake, so that what is really indicated is the speed throughout the performances of one, two, or more movements of the machine. When the finger performs one revolution per minute, the dial is marked at fractions of a revolution with numbers which are the reciprocals of these fractions. For fast speeds, the finger may be made to revolve ten times per minute, and the numbers on the dial would then be multiplied by ten to give the correct speed. Or a ratchet-wheel with a stud may be used so that the speed is indicated only at the termination of five, ten, or twenty movements. The brake and friction-clutch apparatus are similar to those described with reference to Figs. 15 and 17. The connection between the primary lever and the machine the speed of which is indicated may be made in all cases by pneumatic, magnetic, or mechanical means. The indicators may indicate portions of the primary movements.

2962. Soul, M. A., [*Ascough, W.*]. Aug. 24.

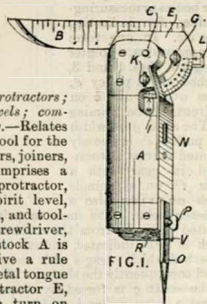

Squares; protractors; clinometers; levels; compasses, drawing.—Relates to a combined tool for the use of carpenters, joiners, &c., which comprises a bevel, square, protractor, slope level, spirit level, rule, compasses, and tool-holder for a screwdriver, awls, &c. A stock *A* is slotted to receive a rule or graduated metal tongue *B* and a protractor *E*, both of which turn on the centre *C*. The protractor is held by a screw *K*, and the tongue is held to the protractor by a screw *G*. Reference marks *L*, *I* are provided

on the tongue and the stock, respectively, to facilitate the parts being fixed at any angle, or the angle being read off. A spirit level *N* is let into the stock. A compass or divider point *O* slides in a recess in the stock, the pointed end of the tongue *B* serving as the second point. A screwdriver, awls, &c., or a pencil, are kept in holes *R* in the stock, which are closed by hinged lids; when in use, they are inserted in the socket *V* and held by a thumb-screw *P*. The taper end of the tongue *B* is used as a knife.

2993. Williams, A. Aug. 26. [*Provisional protection only.*]

Kaleidoscopes.—The objects are placed in a holder rotated by a handle and suitable gearing arranged

3196. Lake, W. R.,
 [*Schneider, R., and Kraft, F. W.*]. Sept. 11.

Surveying - instruments, especially applicable for use in mining surveys, for measuring angles without the use of a magnetic compass. The angle between two cords, or between the two branches of a single cord *S* held by a hook at the angle, is measured by means of two instruments exactly alike, and suspended from the cords. Each instrument consists of a graduated disc *a* fixed to a bracket *C* by a U-shaped piece *B*. The upper end of the bracket *C* carries a box *f*, Fig. 1, through which passes a rack *E* carrying a fork *h*, in which is pivoted a bar *D*. This bar has hooks *e*¹, *e*², and may be suspended from the cord *S* or from a wire *t* on a suspension rail *F*. By means of the rack *E* and pinion *c*, the discs *a* in both instruments can be brought to the same level. Above the disc *a* is a revolving plate *m* fitted with verniers, to read the angle on the disc *a*. Fixed to the plate *m* of each instrument is a bar *n*¹, *n*²; in one instrument the bar carries a magnetized steel plate *k*, and in the other a horse-shoe magnet *z*. Each bar *n*¹, *n*² can be adjusted in its plate *m* by a screw *o* and spring *r*, so

at the side of the case, which contains the reflectors.

3163. Barnicoat, W. Sept. 9. [*Provisional protection only.*]

Levels and plumbing-instruments; clinometers.—Relates to levelling-instruments which may be used as ordinary spirit levels and also for indicating inclines and ascertaining the true level of ceilings &c. Two forms of apparatus are described. In the first form, the case of the glass spirit tube is hinged to a base-plate and provided with a pointer moving over a divided circle fixed to the base-plate. In the second form, a vertical divided circle is fixed to a base-plate, and at its centre is pivoted a pendulum pointer; or the pointer may be fixed, and the circle be movable.

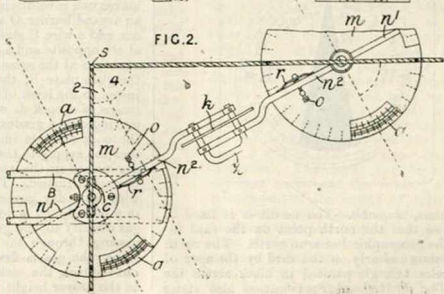
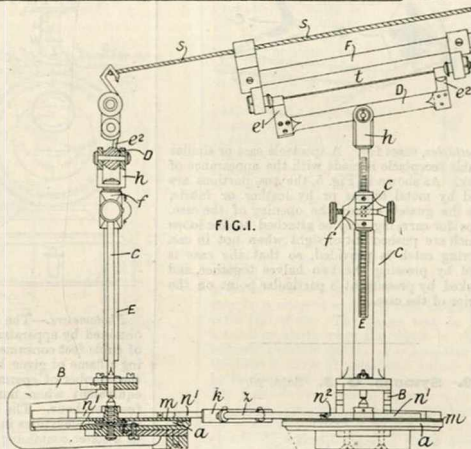

that the plane of contact of the plate *k* and the magnet *z* will contain the centre of revolution of the disc plate *m*. When the plate *k* and the magnet *z* are in contact, the sum of the readings of the two instruments will give the angle $2 + 4$ between the two cords.

3212. Dyk, H. van. Sept. 14.

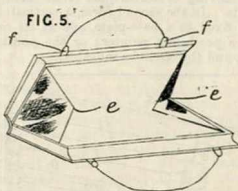

Spectacles, cases for. A spectacle case or similar portable receptacle is made with the appearance of a book. As shown in Fig. 5, the two portions are joined by metal hinges or by leather or fabric, while the gussets *e* limit the opening of the case. Straps for carrying may be attached to the loops *f*, which are pushed out of sight when not in use. A spring catch is provided, so that the case is locked by pressing the two halves together, and unlocked by pressing at a particular point on the exterior of the case.

3293. Symons, G. J. Sept. 20.

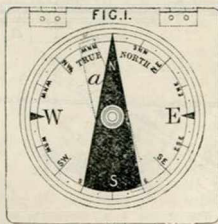

Compasses, magnetic.—The needle *a* is fixed to the card so that the north point on the card indicates the geographical or true north. The north point is shown clearly on the card by the apex of an isosceles triangle painted in black across the card. The Provisional Specification also states

that, in cases where the needle and card are separate, the needle carries an index which points to the true north; also, the needle may be made adjustable for correction in different parts of the world.

3334. Sugg, W. T. Sept. 24.

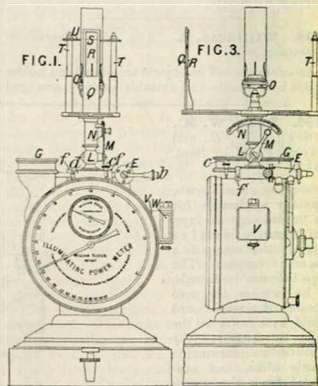

Photometers.—The illuminating power of gas is obtained by apparatus which measures the number of cubic feet consumed in one minute in maintaining a flame of given height and indicates on a dial the number of sperm candles to which the gas is equivalent when burning at the rate of 5 cubic feet per hour. The apparatus is shown in front and side elevations in Figs. 1 and 3, and consists of a meter containing a clock, the hand of which makes one revolution per minute, and supporting an argand burner *O* and frame *Q* which carries at one end a wire *U* stretched between pillars *T*, and at the opposite end a coloured glass plate *R* having a mark *S* at the same height. On looking through the glass plate *R*, the top of the flame can be adjusted to the level of the mark *S* and wire *M* by means of a cock *L* with a pointer and handle *M* moving over a graduated arc *N*. The way through the cock is made in the form of a slot in order that the supply to the burner may be increased or diminished in the same proportion as the handle or cock is turned. The apparatus is also provided with two dry governors or regulators contained in a box *G*, and a bye-pass *E* for conducting the gas directly to the governors and burner without passing through the meter. In using the apparatus, the gas is first passed to the burner without entering the meter, and the flame is adjusted to the proper height. The handle *b* of the cock *E*

is then moved to admit the gas through the meter, and the gas pointer allowed to rotate until vertical and at zero. The gas is then shut off from the meter. The position of the clock-hand is now noted, and the gas is allowed to flow through the meter for one minute, during which the clock-hand makes one revolution. The gas is then shut off again from the meter, the pointer indicating the illuminating power. The meter is fitted with a chamber *V* having glass sides for indicating the water level, and is provided at the top with pillars *f* for receiving a spirit level. The key *c* and stop *d* for the clock are also shown.

3398. Walker, W. T., [Drory, J. F. T.].
Sept. 30.

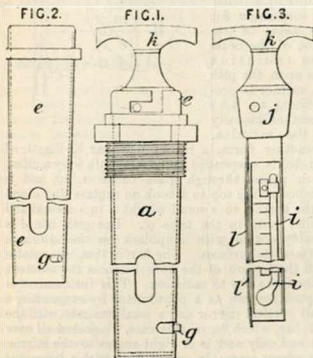

Thermometers.—A testing-cock for ascertaining the temperature of, and detecting impurities in, illuminating-gas in any part of a gas-making plant consists of a conical pocket *a*, Fig. 1, inside of which fits the hollow conical plug *e*, Figs. 1 and 2. The tester consists of a thermometer *i*, Fig. 3, and a spring *l* for holding a piece of test paper, attached to the conical plug *j* which fits into the top of the plug *e*, Fig. 1. When in use, the pocket *a* is screwed into a gas main, and the tester is introduced into the plug *e* and turned until the plug *e* is stopped by the pin *g*. The apertures in the plug *e* and pocket *a* are thus brought together, and the gas has free access to the tester. On turning the handle *k* in the reverse direction, the apertures in the pocket *a* are closed and the tester can be withdrawn.

3540. Kennedy, W. Oct. 12

ULTIMHEAT®
VIRTUAL MUSEUM

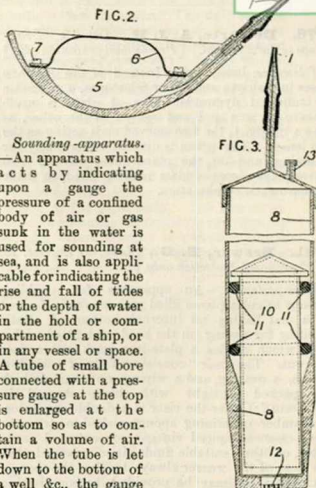

Sounding-apparatus.
—An apparatus which acts by indicating upon a gauge the pressure of a confined body of air or gas sunk in the water is used for sounding at sea, and is also applicable for indicating the rise and fall of tides in the hold or compartment of a ship, or in any vessel or space. A tube of small bore connected with a pressure gauge at the top is enlarged at the bottom so as to contain a volume of air. When the tube is let down to the bottom of a well &c., the gauge will indicate the depth of water. An air pump may be connected with the tube to keep the apparatus full of air. The gauge may be arranged to actuate an alarm when the water in the hold &c. exceeds a certain depth. For sounding at sea &c., the tube is made of vulcanized rubber &c. so as to be flexible, and the chamber at its end is closed. Fig. 2 shows one form of apparatus in which the tube *1* is connected to a heavy chamber *5* containing air and closed by a vulcanized rubber cover *6* secured by a ring *7*. Fig. 3 shows another form; the tube *1* is connected with a heavy vessel *8* containing air and perforated at *12* to allow water to enter and act on a hollow plunger *10* fitted with rings *11* acting as roller packing. As the plunger *10* is forced up by the pressure of water, the air is compressed and the gauge on deck indicates the depth. A hole *13* closed by a screw top is provided for filling the apparatus with air. In a modification, the plunger *10* is fixed to an external cylinder which moves over the outside of the vessel *8* and so prevents water from entering the apparatus. The depth can be taken when the ship is in motion, as the reading of the gauge is independent of the length of tube let out. The tube may be coiled inside a tub or round a drum. An alarm apparatus worked by clockwork may be fitted to the pressure gauge to indicate shallows, and the indications of the gauge may also be recorded by clockwork. Tidal movements may thus be automatically indicated or recorded, the

3576. Delcorte, A. J. H. Oct. 15. *Drawings to Specification.* [Provisional protection only.]

Telescopes, lenses for. Instead of the ordinary lenses in Galilean and other telescopes, a prismatic or truncated pyramidal piece of glass is made concave at one end and convex at the other, as shown in Fig. 1, the two curved ends acting as the two lenses. The prism is divided transversely for focussing, and on the plane faces of the two halves plane pieces of glass may be fixed, to make an achromatic combination.

3701. Brewer, E. G., [Loeb, B.], Oct. 25. [Provisional protection only.]

Face-protectors.—An apparatus for enabling persons to enter places filled with smoke is formed of a hat having an internal bottom of elastic webbing for resting on the head and fitted with a peak which carries a plate-iron mask with a visor in front. The visor “consists mainly of a window pane, a grating, and a wiping contrivance which is packed air-tight with hemp steeped in “glycerin.” Under the visor is a double respirator. A chamber containing sponge soaked in strengthening-essences, spiced vinegar, concentrated ozone water, or other suitable fluids, is so arranged that the nose of the wearer always touches the sponge. An elastic bag may be provided, by compressing which a current of air is forced through the sponge. The hat is secured to the head by a strap fastened to the back of a waist belt.

3706. Pastorelli, F. J. Oct. 26. [Letters Patent void for want of Final Specification.]

Anemometers; current meters; logs.—In an instrument for measuring and recording the velocity of air currents in mines and through ventilators or chimneys, or of water currents, or of vessels, a battery and an electromagnet, connected with a train of wheels which register on a dial the speed of the current &c., are attached to an apparatus which has cups, fans, or vanes mounted on an axle so as to be rotated by the air or water currents.

3860. Crookes, W. Nov. 5.

Radiometers; photometers; thermometers.—Relates to instruments in which motion is obtained by means of light or heat radiation or “actinism,” allowing it to fall on a surface which is freely suspended or balanced in a rarefied space; the surface is then repelled. Rotation of a body is obtained under the same circumstances if the two ends of each surface are unequally acted upon by the radiation, a result obtained by coating the ends of the exposed surfaces alternately with lampblack. In

one form of instrument, a thin surface of pith, paper, mica, or aluminium, &c., but preferably of a non-conductor of heat, and suitably prepared with lampblack or otherwise, is attached to one end of

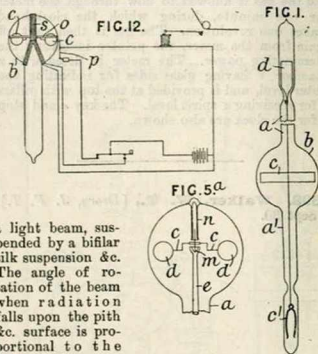

a light beam, suspended by a bifilar silk suspension &c. The angle of rotation of the beam when radiation falls upon the pith &c. surface is proportional to the amount of intensity of the radiation.

In another form, a rectangular bar *c*, Fig. 1, of pith &c. is suspended in a glass bulb *b* by a fibre, which passes through glass tubes *a*, *a'* and is attached at the top to a hook on a glass plug *d* and at the bottom to a small weight *c'* in a second and smaller bulb in the tube *a'*. The pith bar *c* is suitably coated with lampblack on the alternate halves of its surfaces. The bar, in this, case rotates until the torsion of the fibre balances the moment of the force due to radiation. This instrument is adapted for use as a photometer by suspending a small vertical mirror and a small magnet with the pith bar, which is, in this case, blackened all over one end only and is at right-angles to the mirror. The mirror serves, in conjunction with a lamp and horizontal scale, to indicate deflections of the pith bar. The two sources of light to be compared are placed one facing each side of the bar, and are adjusted to distances from it such that the deflection produced by each, acting alone, is the same as, but in the opposite direction to, that produced by the other, or such that no deflection is produced when the two act at the same time. The intensity of radiation at the pith bar is then the same from each, and the comparative powers of the two sources can then be calculated. A control magnet in an adjustable holder may be mounted on the outside of the tube *a*, Fig. 1, and the tube *a'* may be dispensed with. As the dark infra-red and the ultra-violet rays of the spectrum of white light affect the pith bar, they require to be screened off by suitable screens, composed preferably of glass cells containing an aqueous solution of alum and quinine bisulphate. Other rays may be cut off by the interposition of suitable screens. The instrument is stated to be applicable as a thermometer if a screen of a solution of iodine in carbon bisulphide, allowing only infra-red heat rays to pass, is used.

A third form of the instrument, in which continuous rotation under the action of the radiation is obtained, is provided with four light vertical discs *d*, Fig. 5^c, which are mounted on light arms *c* and are supported by a needle point resting in a cup *m* on the upper end of a glass stem *e*. The stem *e* is attached to the depending tube *a*, which is drawn out and sealed after exhaustion. To prevent displacement of the needle from its support, a vertical tube *n* may be placed over the upper end of the needle and sealed to the glass bulb *b*. The needle point may otherwise be attached to the upper end of the stem *e*, and the cup, now inverted, attached to the centre of the arms *c*. In another class of instrument, a large number of inclined vanes are mounted on an equal number of arms *c*, and are blackened only on their upper faces, so that the radiation falling vertically upon the instrument acts on all of the vanes to produce rotation. A similar vane-wheel may be mounted on a horizontal axis, and is actuated by means of radiation falling

upon it in a horizontal direction. The bulb of glass envelope may, in all cases, be caused to revolve if the arms and discs or vanes are held stationary and the bulb is free to move. The bulb may be placed in water or otherwise suspended and a magnet attached to the arms of the vane-wheel in order to hold the vanes stationary. In the photometric arrangement shown in Fig. 12, the vanes *c* revolve and the attached magnet *o* moves a small external magnet *p* at each revolution so as to complete an electric circuit in which is placed a Morse telegraphic instrument. The intensity of the light or other radiation which falls upon the vanes *c* is proportional to the speed of rotation of the vane-wheel, which, again, is proportional to the number of dots made by the Morse instrument in any definite length of the paper strip. The powers or intensities of two sources of radiation can thus be compared. An external coil *s* is provided round the bulb *b*, for the purpose of starting the rotation of the vane-wheel when the radiation is slight.

3991. **McGregor, D.** Nov. 17.

Compasses, magnetic; course correctors. — Relates to means for verifying compass indications by observation of the sun's position. A weighted disc, showing the points of the compass, is carried by a gimbal ring 4, and supports, by a short spindle 9, a tubular pillar 8, having a pointer 10, which, by means of an arc and a set-screw 12, sets the pillar relatively to the disc according to the magnetic variation of the locality. The pillar 9 supports a vertical semicircle 13, which shows degrees of latitude and is adjustable on a horizontal axis, being fixed in any position by a screw 14. The semicircle carries a graduated circle 15, adjustable on an axis at right-angles to that of the semicircle. A bar 16, with cross-wire sight vanes 18, 19 moves over the circle 15, and is adjusted by a pointer 20 to the proper degree for the sun's declination at the time of operation. After setting the instrument for latitude and declination, and with a

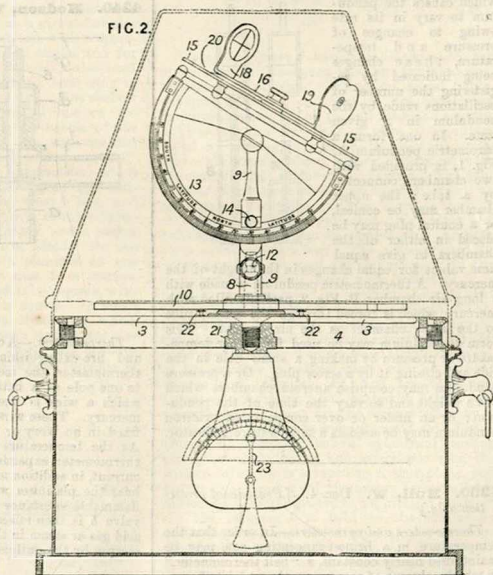

mark on the box in the direction of the ship's head, the disc 3 is turned and the circle 15 adjusted until the sun is sighted by the vanes 18, 19. The point of the compass then opposite the mark

on the box gives the true magnetic direction of the ship's head, and is compared with the reading of the ordinary compass. The disc 3 is adjustable on a central pin on the cross-bar 21, and is moved by means of two pins 22. The heel of the ship at the time of observation is indicated by a clinometer 23 on the outside of the box, or by mounting the gimbal ring on fore-and-aft pivots and providing a scale at the sides which would show the amount the ring rises above the top of the box. The instrument may be modified by substituting for the half-circle 13 a vertical circle turning on a horizontal axis in an external ring or holder on the pointer 10. The circle 15 may then be replaced by a diametrical bar jointed within the vertical circle and carrying the bar 16.

4130. Stanley, W. F. Nov. 29.

Barometers; thermometers.—A pendulum is formed with a chamber containing mercury or other material or fluid which causes the pendulum to vary in its rate owing to changes of pressure and temperature, these changes being indicated by registering the number of oscillations made by the pendulum in a given time. In one form, a barometric pendulum A, Fig. 1, is provided with two chambers connected by a tube; the upper chamber may be conical, or a conical plug may be placed in either of the chambers to give equal time values for equal changes in the height of the mercury. A thermometric pendulum is made with a long air chamber B, Fig. 2, partially filled with mercury, which is forced through the central tube to the upper chamber as the air expands. This form of pendulum may be used for either temperature or pressure by making a small hole in the side and closing it by a screw plug. Or a pressure pendulum may comprise aneroid chambers which lift a weight and so vary the time of the pendulum; or an under or over compensated gridiron pendulum may be used as a temperature indicator.

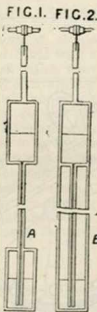

4200. Bull, W. Dec. 4. [Provisional protection only.]

Thermometers and pyrometers.—In order that the temperature in a brine-evaporating pan may be maintained nearly constant, a "bell thermometer," in which columns of mercury make and break contact with two platinum wires, is placed in the pan. The platinum wires are separately connected to the

opposite poles of an electric battery, a bell being placed on the negative wire and another on the positive wire; the bells are separately operated when the temperature falls and when it rises beyond predetermined limits. A "bell pyrometer," fitted with a rod carrying projections which make contact with the opposite poles of a battery, is similarly fitted to the furnace which heats the pan.

4225. Huet, A. F. Dec. 6. [Provisional protection only.]

Pyrometers.—The expansion of a copper rod, contained in a porcelain tube inserted in an opening in the walls of a furnace, is transmitted by a lever to a piston, which forces a liquid up into a graduated glass tube and thus indicates the temperature. The part of the porcelain tube inside the furnace may be perforated.

4240. Hodson, V. Dec. 7.

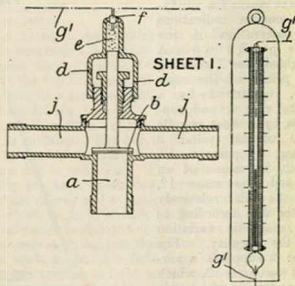

Thermometers.—A combined automatic fire-alarm and fire-extinguishing apparatus consists of a thermometer, the mercury in which is connected to one pole of a battery, and in the upper end of which a wire is fixed out of contact with the mercury. These wires g' meet in a platinum loop fixed in an ivory or other non-conducting plug f. As the temperature rises, the mercury in the thermometer expands and closes the circuit; the current, in addition to sounding an alarm, will also heat the platinum wire, thereby igniting an inflammable substance c, such as gunpowder. The valve b is then raised by the pressure of carbonic acid gas or steam in the inlet a, and the steam &c. escapes by the outlets j to extinguish the fire.

4433. Henderson, R. Dec. 16.

Compasses, magnetic; angle-measuring instruments; levels and plumbing-instruments; goniometers; surveying-instruments; lenses; polarizers.—Relates to a combination instrument which contains and may be used as a dial, prismatic compass, circumferentor, "hypothonite," limb for taking vertical angles, quadrant, sun-dial, level, protractor, scale of inches and chains, thermometer, barometer, anemometer, clinometer, double callipers, plummet, magnifying-lens, Nicol's prism, and goniometer. It consists of three boxes hinged together so as to fold up into one. The top box contains a floating dial compass provided with stops, and a hinged prism for reading the needle. It is also provided with a movable ring divided into hours &c. to be used as a sun-dial, and contains at the side a thermometer and double callipers; the outside edges are marked with scales of chains and inches. Between two of the boxes is a plate which acts as a cover to either box and is covered with formulæ for mining engineers and surveyors. To this plate is hinged a style having a fine slit in it, by means of which the magnetic variation of the compass can be determined. The fine slit in the style is used with the sight above the prism as a circumferentor sight. The style is also combined with a quadrant and used for taking vertical angles and for measuring angles of crystals &c.; it is also used in conjunction with the graduated hour ring to cast a shadow and form a sun dial. The shadow is made to coincide with a central line on the plate, and the time is read by the needle of the dial and the hour ring. "In this way any dial or compass may be converted into a sun-dial." The second box contains the anemometer, which consists of eight fans, with bevel gear and indicator. In the corners of the second box, and visible when using the dial, are a circular level, a magnifying-lens, a Nicol's prism, and a socket into which a tripod head can be fitted. On the other side of this box is a plummet in one corner, and around the fan case is a narrow movable circular plate divided into degrees, with a clinometer suspended at its centre. A small level is preferably fitted as a clinometer, which is also used in connection with two sights for taking vertical angles. The third box contains an aneroid barometer, and is divided outside to serve as a protector.

4434. Webster, J. Dec. 22.

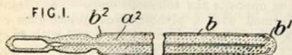

Thermometers.—The graduations of a clinical thermometer are protected by a glass tube b , having the end b^1 fused to the end of the stem, while the opposite end b^2 is moulded round, a shoulder a^1 and afterwards sealed by cement or varnish.

4552. Bessemer, H. Dec. 31.

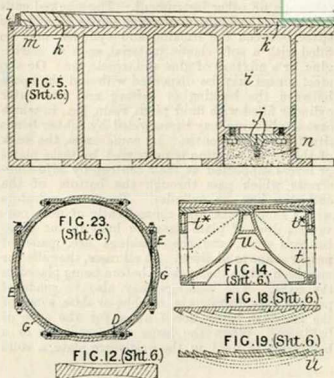

Lenses; reflectors; telescopes.—Relates to the manufacture of lenses and reflectors for telescopes, heliostopes, "cameras," lighthouses, signal lights, daylight reflectors, &c., and to the machinery employed therein. The general form and contour is given to discs or pieces of glass or speculum metal by turning in a lathe, the tool of which moves horizontally about a pivot coincident with the centre of the surface to be formed. The tool is fitted with a piece of carbon, black diamond, or other gem. The spherical figure given to the lens or reflector is further perfected by grinding and polishing, and may also be figured to a parabolic curve in the ordinary way. The reflectors are silvered, except those used for heliostopes. In the manufacture of very large glass reflectors, it is necessary to strengthen or support them so that they will not bend under their own weight. This may be done by fusing together any number of sheets of plate glass; the plates are ground flat and covered with a wash of silicious and alkaline matters, as, for example, powdered glass, with or without boracic acid, pearlsh, &c., and are then put together in a "bung" and heated in a kiln. Or a single plate or sheet may be strengthened by a light strong cellular backing of metal &c. Fig. 5 (Sheet 6) shows a hollow cylindrical casting strengthened by radial and concentric ribs, the surface of which is scraped to a true plane and has in it a number of concentric grooves, connected by a radial groove to an airtight chamber i . The reflector k is held on the backing by atmospheric pressure on exhausting the air from the chamber i through a cock j . The space a is filled with pitch &c. to prevent the ingress of air. Between the reflector and the ring l is cast some elastic material which will allow for expansion and contraction. To prevent distortion of the cylindrical casting or backing, it may be supported



by thin steel straps D, Fig. 23, within a cylinder G having suitable flanges for attachment to a telescope or other instrument. The screwed ends of the steel straps pass through bosses E, and the space between the backing and cylinder may be filled with a soft elastic material, such as marine glue, or a mixture of glue and treacle, &c. Or the steel straps may be dispensed with and the space between the backing or casting and the outer cylinder filled with fluid pitch, resin, &c., in which case the backing may be held by rubber bands fitted or not in grooves. In some cases, the back of the cellular casting is supported by three plates or levers supported at their centres by adjusting-screws which pass through the bottom of the enclosing box or cylinder. To form reflectors with a short focus, and consequently of deep curvature, discs of plate glass are bent in the glass-bender's oven, and the backings are made of proper shape to fit them. In all cases, the reflector may be fixed to the backing before being placed in the lathe. The backings may also be made of pottery ware, terra-cotta, marble, or slate, some of the material being bored away for the sake of lightness. When the large glass reflector of a helioscope is used in the unsilvered state, a solid

metal backing cannot be used, in which case a backing constructed as shown in Fig. 14 is employed. This consists of a hollow double cylinder having vacuum chambers c^1 , communicating with grooves in the upper surface on which the flat outer edge of the reflector rests. The centre of the reflector also rests over a vacuum chamber in a casting u , which casting has silvered sides so that heat rays passing through the lenses are reflected through holes in the outer cylinder. In a modification, a central vacuum chamber is connected to the cylinder by thin radial ribs, grooves being formed in the ribs and the upper edge of the cylinder. In other cases, reflectors are built up by cementing the two discs together or by cementing a plano-concave disc on either side of a plain disc. Reflecting or refracting surfaces may also be formed by turning successive annular rings or zones in the faces of discs of plate or other glass, as shown at Figs. 18 and 19, such grooves or inclines being segments or portions of a sphere, parabola, cone, &c. In all cases, the edges of the discs are turned truly circular before being removed from the lathe, and they may be recessed or grooved, as shown at Fig. 12, to ensure correct re-chucking.

A.D. 1876.

91. Wilson, R. P. Jan. 8. [*Provisional protection only.*]

Thermometers.—A thermometer combined at its upper end with a watch movement or any other time-keeping apparatus "having a hand pointing to certain divisions indicating any desired period of time between them" is employed in a method of testing petroleum and other liquids. The thermometer tube is arranged in close proximity to the path of the hand or pointer, and the flame of the lamp employed in the process is regulated so that the mercury in the thermometer rises at the same rate as the rate of advance of the hand or pointer.

148. Bohne, C. Jan. 14.

Levels and plumbing-instruments; angle-measuring instruments.—Relates to a pocket instrument for

levelling and measuring vertical angles, which may be used for measuring distances and heights and also as a substitute for a plumb level in building &c. Figs. 1 and 2 (Sheet 1) show one form of instrument consisting of a telescope C, C^1 suspended within a closed cylindrical casing E, E^1 by means of a bow-frame B, B^1 hung from rings A, A^1 pivoted together by steel axle-pins to form a gimbal arrangement. Glasses e , e^1 are fitted in the casing opposite the telescope ends. The telescope is formed with a plano-convex object glass c to which is fitted a micrometer c^1 , and with an eyepiece e^1 consisting of a plano-convex lens and a double concave lens having a small central perforation "for the exposure of the summit of the concave lens." The bow frame B, B^1 terminates in a disc D, D^1 having a rubber band to prevent injury from contact with the case, and it is fitted with a screw d , d^1 for adjusting and correcting the sight of the telescope. The casing is fitted with a



handle E'' by which the instrument is held when in use. A screw F passing through the handle serves to lock the suspended part of the instrument

a simple line or hair sight may be substituted for the micrometer. The lines of the micrometer may be cut with a diamond, or, when corroded by hydrofluoric-acid gas they may be blackened. The

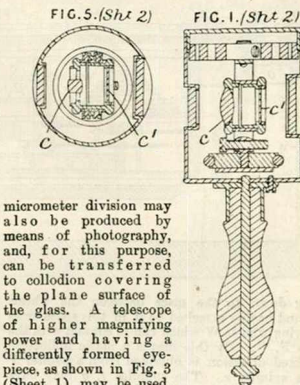
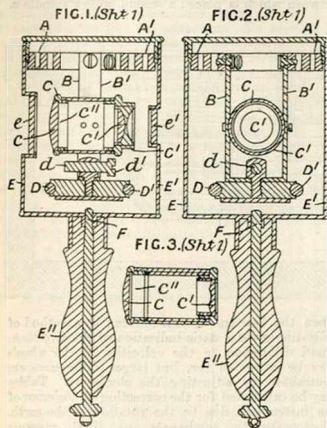

micrometer division may also be produced by means of photography, and, for this purpose, can be transferred to collodion covering the plane surface of the glass. A telescope of higher magnifying power and having a differently formed eyepiece, as shown in Fig. 3 (Sheet 1), may be used. Figs. 1 and 5 (Sheet 2)

when not in use. The instrument not only indicates the horizontal direction but also measures the tangents of the vertical angles by means of the micrometer. For levelling only, a diaphragm with

show another form in which the sides of the eyeglass c are cut away to leave spaces through which the object can be viewed directly, while the lines of the micrometer c' are seen through the central portion or strip of the lens.

288. Janse, L. Jan. 25.

Course indicators.—

A "direction indicator," for use in the maintenance of a fixed direction and also for showing the deviations and errors of a magnetic compass, is provided with one or more heavy rotating wheels, which are mounted and driven so as to be independent of any angular horizontal motion of the supports, and by means of which the fixed direction is indicated. In one form of the instrument, two similar heavy-rimmed wheels F, G , Fig. 2, are mounted in a bowl B , and are each driven by two similar clockwork trains, modified from the Earnshaw chronometer escapement, so as to drive two pointers H, I at equal speeds in opposite directions; toothed wheels j, p transmit the motion of the spindle f and wheel F to the spindle k of the pointer H , and wheels k, q similarly

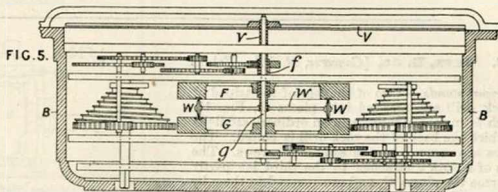

transmit motion from the spindle g to the hollow spindle i of the pointer I . The points of coincidence of the pointers indicate a fixed direction on the compass card R . The bowl B is supported by a gimbal ring C , the external pivots of which are carried by a toothed ring D in the box A . By means of a fixed pinion in gear with the rings D , the bowl B may be set round, as desired, in the box A . The driving-force of the springs is communicated to the wheels F, G in small impulses.

Corrections for friction and for the effect of circular motion of the support on the driving-impulses may be made by means of a small slide S, which is adjustable in a graduated ring T in order

to exhibit the algebraic sum of the corrections. In a second form of the indicator, the wheels F, G, Fig. 5, are mounted on concentric spindles *f*, *g*, between which is placed a second hollow spindle *e*,

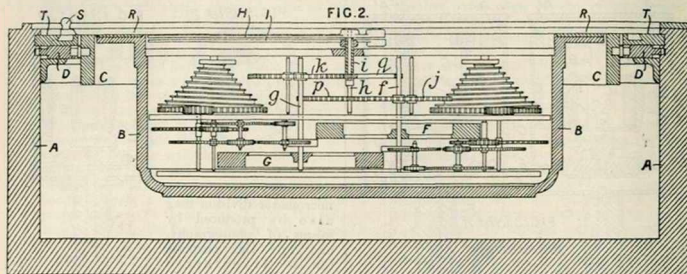

passing down to the space between the wheels F, G, and having attached to it in this space arms *w* carrying wheels W which run in contact with the wheels F, G. By this means a static indication of a fixed direction is obtained from a pointer V on the spindle *v*. The spindles *f*, *g* may have pointers attached as in the first case, or discs may be fixed to them in such a manner that a white radial line on the black surface of the lower disc is seen through a narrow radial slit in the upper disc

when the two are in coincidence; this method of indicating gives a static indication of the direction. Small differences in the velocities of the wheels may be corrected for, but larger differences are neutralized by adjusting the clockwork. Tables may be calculated for the correction of the error of the instrument due to the rotation of the earth. Electromagnetic appliances, or fluid pressure actuating a turbine or a Barker's mill, may be used for driving the wheels F, G.

334. Fisslthaler, J. Jan. 27. *Drawings to Specification.*

Compasses, magnetic; thermometers; barometers.
—Relates to the forms of perpetual calendars

described in Specification No. 2868, A.D. 1875, [*Abridgment Class Registering &c.*], which are combined with or applied to magnetic compasses, thermometers, and barometers, amongst other articles.

408. Pass, E. de, [*Converse, M. D.*]. Feb. 2.

Tripod stands.—Two of the legs of the tripod of a rock drill are screwed into pieces G, Fig. 11, which fit in conical recesses in an ordinary saddle H to which the back of the rock drill is bolted. The pieces are secured to the saddle by screws. The ends of a fork J attached to the third leg partly embrace the pieces G, and are secured to them by bolts *p*. Each leg has a sliding foot *k* adjusted by set-screws, and may be provided with weights.

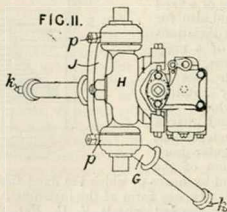

433. Haddan, H. J., [*Wheeler, M.*]. Feb. 7. [*Provisional protection only.*]

Latitude instruments.—A "solar chronometer" for ascertaining time and latitude by the sun

consists of a semicircular concave plate which represents a zone of the earth extending equally on each side of the equator a distance equal to the obliquity of the ecliptic. The ends of the semicircle are connected to a plate representing the

earth's equatorial diameter and having a central hole through which the sun shines. The inner surface is graduated with declination lines, traversed at right-angles by hour lines which are 15° apart minus a correction for refraction. To allow the instrument to be used in any latitude and with its circle parallel to the equator, the circle is pivoted horizontally to two uprights on a stand, and is held in any desired position by means of a hinged rod connected at one end to the bridge or plate of the circle, and at the other end to a clamp sliding in a bevelled groove on a graduated latitude bar forming part of the base or horizon plate; the latitude bar may be provided with a vernier. The instrument is set at noon to the latitude of the place by bringing the image of the sun on the point of intersection of the meridian or 12 o'clock hour line with the declination line for the day and hour; the latitude is then shown on the bar.

502. Boisseau, P. F. Feb. 8.

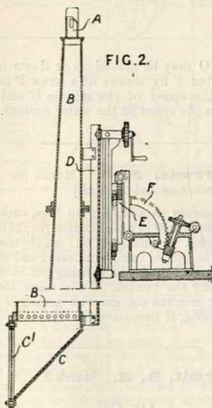

Reflectors.—A "submarine spy-glass," for inspecting the bottoms of ships, and other submerged structures, consists of a water-tight conical tube B, supporting at its lower end a plain glass plate c' and a silvered glass C, and at the top an eye-piece A. Toothed segments E, F enable any desired inclination to be given to the tube, while it may be raised or lowered by a rack D fixed along its whole length. The spy-glass may be used separately, or in conjunction with a brushing-apparatus for cleansing the structures inspected.

554. Brewer, E. G., [Segoffin, Feb. 11.

Mathematical drawing - instruments, cases for. The hair brush shown in Fig. 1^{bis} is formed with a hollow back and handle to contain a number of toilet articles, but may also be used to contain engineers' mathematical instruments. The lid h at the end is jointed at h' , and is secured by a spring catch i which is released by pressing a stud i' . The articles may be removed at the end h , or at the handle end, which is provided with a pivoted lid or cover.

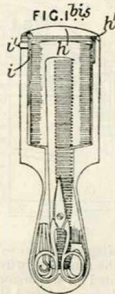

In a modification, the back is covered by a sliding lid. A clothes brush is similarly fitted, or the articles are held in a tray or in a drawer fastened by a spring catch and released by a button.

642. Lake, W. R., [Bent, S.]. Feb. 16.

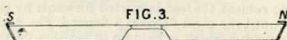

Compasses, magnetic.—The card is arranged to indicate the true or geographical north, the needle being adjustably secured to the underside by the screw C, Fig. 1, which also forms the pivot. The needle is shaped as shown in Fig. 3, and is provided at the ends with pointers N, S which are bent over the edge of the card, as shown in Fig. 4, and adjusted to the magnetic variation. For distinction, the pointer at the north pole N is sharpened, while that at the south pole S is broadened.

694. Hicks, J. J. Feb. 18. [Provisional protection only.]

Thermometers.—Relates to clinical and other thermometers in which the scale is marked on the tube or stem and covered by an outer protecting-tube, and consists in filling the space between the stem and protecting-tube with transparent cement to prevent the admission of moisture &c.

752. **Clark, A. M.**, [Kirtland, C. E.].
Feb. 23.

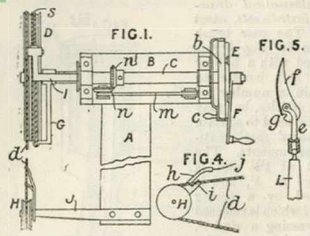

Sounding-apparatus.—The wheel D, Fig. 1, upon which the sounding wire, line, or cable *s* is wound, is mounted on a horizontal shaft C which rotates in bearings on a board B fixed to the rail A of the vessel. The cable *s* passes through a hole in a loose arm G on the shaft C and is maintained in position upon the wheel D by a roller attached to a fixed arm L. The shaft C and wheel D can be rotated by means of a crank-handle F, a stop or projection upon which is, for this purpose, engaged in one of several recesses on a wheel E fixed upon the shaft C. A band brake *b* provided with a handle *c* is fitted over the wheel E. An indicating-band *m* passing over two pulleys is driven from the shaft C by bevel-wheels *n*, *n'*. Arrangements for tripping the lead are also provided. An endless cord *d* passes over the wheel D and also over another wheel H, mounted on an arm J attached to the rail at about one hundred feet beyond the wheel D. The lead L, Fig. 5, which is attached to the cable *s*, is suspended by a stirrup *e* from a trip-piece *f*, which, when the lead is to be thrown, is hung with the slot *g* over the cord *d*. The wheel E being rotated, the lead is carried forward by the cord *d* until the piece *f* strikes a finger *j*, Fig. 4, on a loose piece *h* which is held up in position by the cord *d* passing through a hole *i* in it. At this point the lead drops from the cord *d* and falls, the operator at the same time disengaging the crank F so that the cable *s* runs free. The brake *b* is used to stop the wheel D when the lead strikes the bottom, and the band *m* then indicates by means of its graduations and a fixed pointer the depth of water. The cable *s* is afterwards wound again upon the wheel D.

779. **Fleury, F. G.** Feb. 24.

Logs.—In a ship's log which registers the speed of the water flowing past the ship, an outer casing A communicates by means of an inlet B and a pipe with a scoop &c. for catching up the water. The water is directed by adjustable nozzles G into a chamber E, and there acts on vanes K so as to cause the spindle L to rotate. This spindle carries a tangent-screw M at the top, which

actuates suitable registering-mechanism, and at the bottom carries other vanes S which rotate in another chamber F. The water escapes from the chamber E through ports H to the outlet C.

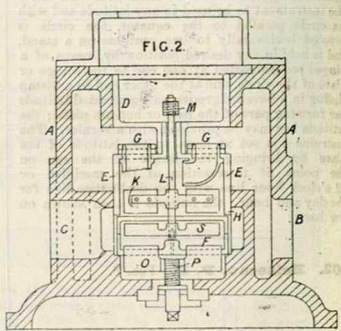

Fixed vanes O may be moved up or down in slots in the chamber F by means of a screw P in order to regulate the speed of the spindle L and vanes in relation to the speed of the water current.

1002. **Browne, J. C.** March 8. [Provisional protection not allowed.]

Logs.—Consists in adapting to logs, such as the Russell log described in Specification No. 2619, A.D. 1875, an index mechanism by which the speed during a given period can be indicated and read off, the log and index mechanism being put in connection and under the control of the same tow-rope. Time-giving mechanism may be arranged within the same casing, if necessary.

1030. **Armit, R. H.** March 9.

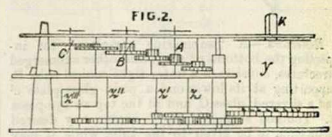

Logs.—The apparatus consists of a counter for indicating the distance travelled, and an ordinary spring balance with the dial graduated to indicate the speed corresponding to the resistance of the log line. The counter consists of a train of wheels A, B, C, Fig. 2, with a single dial or with dials graduated in units, tens &c., and is driven by a

barrel y on which is wound a catgut, silk, or other cord or chain attached to the log line. The barrel y also drives a train of wheels z, z^1, z^{11} , terminating in a fly z^{111} . When two or more barrels are

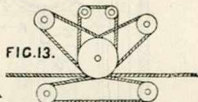
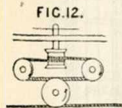
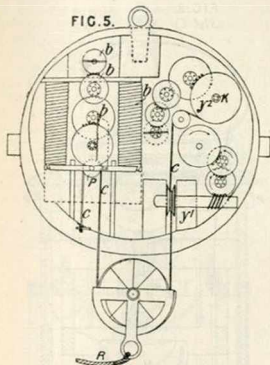

employed, as shown in Fig. 5, the first y^1 drives the counter, while the second acts as the feed or supply and drives the regulating-fly. The cord or chain is wound or re-wound by a key applied to a square K on the barrel y or y^1 , the amount of winding being proportional to the time the counter is to run. The pointer of the spring balance is steadied by a regulating-fly b driven by a train of wheels from a pulley P and the cord or chain c , which is then passed round a pulley on the log line R , as shown. In some cases, the barrel and cord are replaced by springs, as in a clock, and instead of the ordinary spring balance a flat semicircular spring is used, having one end secured to the containing case while the other end is connected by a chain with a fuse on a pinion gearing with a quadrant attached to the clockwork. The log line is then connected with the quadrant. The flat spring regulates the motion of a train of wheels passing through the clockwork by a lever escapement. The clockwork may be arranged to record on the dial plate the exact time of day and the time at which the log was set. A weight may be suspended at the inner end of the log line to compensate for any reduction in length of the latter. Figs. 12 and 13 show other means for working the distance dial.

1052. Roberts, W. H. March 10. VIRTUAL MUSEUM

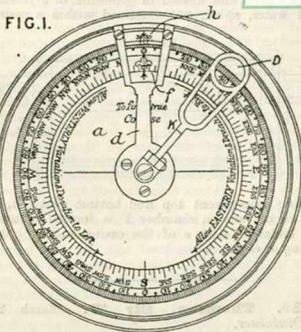

Course corrector.—To ascertain the true course from the course indicated by the compass, the instrument shown in Fig. 1 is used. It consists of a dial a with an inner circle divided into points indicated by letters in the ordinary way, and an outer circle divided into degrees which are numbered from 0 to 90 in each direction from the N and S points. The arm d , pivoted at the centre of the card, is provided with an index f for reading the inner circle and a vernier h for the outer circle. The various calculations are made by moving the arm a proper distance round the dial to the right or left, as the case may be, the true course being read on the outer circle. The reading of the vernier h is facilitated by a lens D on a hinged arm K .

1128. Lowne, R. M. March 16. [Provisional protection only.]

Anemometers.—In instruments for measuring the velocity of currents of air or gas, the fan blades are formed of vulcanite, and the gearing communicating with the counting-apparatus is protected from dust by forming the worm of the same diameter as or of smaller diameter than the spindle, or by using a toothed wheel, which enables the spindle to pass through a closely-fitting hole in the case of the counting-gear. In anemometers of the class known as "Byram's" anemometers, a lever acting on suitable mechanism is provided for throwing the counting-apparatus in or out of gear with the wheel or pinion on the axis of the fan.

1149. Wells, N. March 17.

Compasses, magnetic.—Liquid compasses are constructed with transparent cards and transparent tops and bottoms to the enclosing-casings, to enable

them to be read from above or below. Fig. 3 shows a liquid compass having a talc card B carried upon a pivot and floated in glycerine, or glycerine and water, spirit, &c. contained within a casing

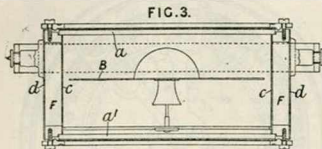

having transparent top and bottom plates *a, a'*. An air or vacuum chamber *F* is formed between the metal &c. sides *c* of the casing and an outer lining or casing *d*.

1339. Thomson, Sir W. March 29.
Disclaimer.

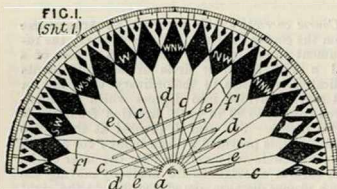

Compasses, magnetic; bearings, instruments for determining.—Relates to a form of mariner's compass, and to means for ascertaining and correcting its errors. A central aluminium boss *a*, Fig. 1 (Sheet 1), provided with a central cap or bearing of sapphire, ruby, &c. is connected by silk threads *c* with an aluminium rim, the compass card being partly supported by the threads and partly by the rim, as shown. The compass card is formed in sections connected by strips of gummed paper, and it is secured to the rim by tongues. Two or more small magnets *d* (eight are used in the form shown) connected together by silk threads *e* are attached to the rim by means of four silk threads *f'*, being arranged on each side of the pivot. By this arrangement, the frictional error is reduced and, with eight needles, as long a period of free oscillation as is suitable for working well at sea is obtained. The gimbals are swung on knife-edges *g* to enable the compass to take up a truly level position, and it is steadied by means of a bowl *A* containing a viscous liquid and attached to the bottom of the glass case containing the needle. The correctors for the quadrantal error consist of iron balls &c. placed in boxes fixed to the sides of the binnacle. The semicircular error is corrected by steel magnets. Two correctors *E, F* are used, as shown in Fig. 3 (Sheet 1), one for the fore-and-aft force and the other for the thwart-ship force.

Each corrector consists of two bar magnets *G, H* of equal strength and movable round a common axis either by hand or by means of gearing. The magnet *G* consists of two side portions between

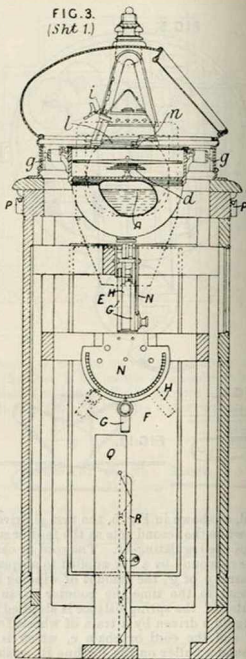

which is arranged the magnet *H*. When the magnets are closed in the vertical position, their combined action at a distance is zero; they may be deflected to form any angle and so regulate their action, graduated discs *N* being fitted to facilitate adjustment. A single corrector having an azimuthal adjustment may be used. When there is a large amount of error to be corrected, auxiliary correcting permanent magnets *P* are used which are preferably placed level with the compass or as close as possible under the quadrantal correctors. These magnets are preferably formed of hard-steel wire or rod soldered in brass tubes to protect them from rust &c., and made in pairs of equal strength and with ends shaped so that they can only be packed away with dissimilar poles together. For correcting the heeling error, a magnet *R* is adjustably carried in a groove in an upright *Q* placed

within the binnacle. An appliance is provided for taking magnetic azimuths of suns or stars or terrestrial objects, which appliance may be applied to any form of compass. It consists of a convex half-

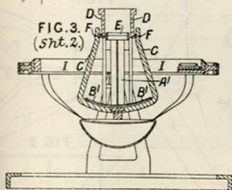
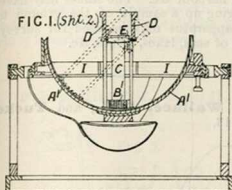
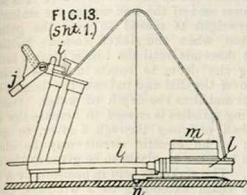

lens *l*, Fig. 13, fitted with a hinged mirror *j* and placed over the compass with its axis directed to the graduated circumference of the compass card. The lens *l* and mirror *j* are carried by a frame *l* capable of rotating on the centre *n*. The observer, when taking an azimuth, turns the frame until the mirror and lens are opposite the object. He then places his eye above the compass and moves the image mirror *j* about its horizontal axis, until the image of the object reflected from the mirror is seen upon a division on the compass card seen through the lens. The point on the compass card where the object is seen will be the bearing of the object. A separate instrument, called a detached azimuth circle, is also provided for finding the true north directly by observations of the sun, moon, and stars, and thus ascertaining the error of the compass. It consists of horizontal inner and outer circles mounted on knife-edge gimbals; the inner circle is graduated to degrees and marked

with compass points and it carries a portion of a hollow sphere pivoted on a horizontal axis and marked with a great circle corresponding to the equator and with circles corresponding to degrees of declination, which circles are graduated into time divisions numbered in hours and minutes. A lens is placed with its centre at the centre of the spherical surface, so that its axis may be directed to any point. Figs. 1 and 3 (Sheet 2) show a modified form of detached azimuth circle in which only a strip *A'* of the curved or spherical surface marked with the equatorial circle is used while a sector *B'* marked with declination circles is connected by arms *C* with the frame *D* of the lens *E* and is movable with the lens round the polar axis *F* of the spherical surface. The equatorial circle *A'* is pivoted on a horizontal axis and carried by the inner circle *I*, which is divided into degrees and marked with the points of the compass. To use the instrument, the plane of the equatorial circle is set for the latitude of the place, and the lens frame is turned round the polar axis until the bounding meridians agree with the hours marked on the equatorial circle corresponding to the integral hours of apparent time, the inner azimuth circle being turned round its axis until the image of the body observed falls on the point which corresponds to the declination and time. The instrument is placed with the diameter through the lubber point on the outer circle parallel to the ship's length, and, when the inner azimuth circle has been set, the angle between the lubber point on the outer circle and the zero on the inner circle is read and compared with the angle between the north point and lubber point of the compass, the difference between the readings being the deviation of the compass from the true north. In another modification, a single circle is divided for time on a narrow strip of the spherical surface and the frame containing the lens is fixed in a geometrical slide so that the centre of the lens may move in a straight line through the centre of the circle, and at right-angles to the plane of the circle. A screen and mirror may also be used. The Provisional Specification states that a circular disc may be suspended in the bowl to steady the compass, and that iron cylinders, or ovals, or bundles of soft-iron wire may be used for correcting the quadrantal error.

1455. Kelway, C. E. April 5.

Logs; current meters.—Relates to apparatus of the form known as Massey's log for ascertaining the rate at which vessels are passing through the water, or the rate at which streams or currents are flowing, and consists in arrangements for making electrical communication, at regular intervals, between the ends of two insulated wires in the tow-rope of the apparatus, the other ends of the wires being connected with an indicating-apparatus and galvanic battery on board the vessel. Fig. 7 shows a plan view of a log. The rotator *d* is connected by a bar or rope *e* to the mechanism of the indicator contained in the log *b* which is attached to the vessel by the tow line *a*. Beneath the log is fixed a divided box *c*, Fig. 1, containing

an insulated pivoted lever e , one end of which is acted on by a cam-wheel t on the end of the mile spindle a , while the other carries a platinum point k for making contact with a plate c and thus completing the circuit through the wires o, n to operate

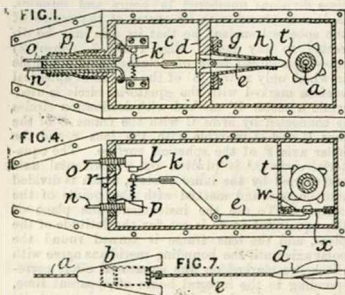

the indicator on board the vessel. The opening in the division d is kept water-tight by an elastic sleeve g , one end of which is secured to the division and the other embraces the lever e at h . The insulated wires o, n pass through an opening in the front of the box which is kept water-tight by the flexible tube p . The wires may be connected to screwed studs passing through non-conducting plugs p, r , Fig. 4, in the end of the chamber and coated with insulating-material. Fig. 4 shows an arrangement in which the lever e is operated through a plug w fixed to the centre of a flexible diaphragm x and acted on by the cam-wheel t . Contact may also be made to complete the circuit by means of a non-conducting disc, having a metallic plug or section, rotating between two springs connected to the wires. The lever may be replaced by a flexible bar fixed at its front end, or by a sliding bar. To prevent ships' logs from being raised out of the water by any sudden increase of the vessel's speed, a float or weight is attached to the tow line between the vessel and the log. A bell may be attached to the indicating-apparatus.

1518. Clark, A. M., [Wagner, F. X., and Schoenberg, A.]. April 11. [Provisional protection only.]

Sounding apparatus.—Relates to apparatus applicable to all ships in place of the ordinary lead, for indicating shallow water by sounding an alarm and also for automatically showing the exact depth of water beneath the vessel. The apparatus consists, principally, of a sinker suspended from a sounding-line, which passes over a registering-apparatus and is counterweighted to register the depth of water as soon as the sinker strikes ground. A shaft mounted in a frame fixed to the vessel's side is forked at one end to receive the pivoted

case or shell of the registering and alarm apparatus, in which is hung a drum and gearing actuating a pointer moving over a dial. The upper part of the sounding-line passes around the drum, and thence downwards around a pulley hung in a counterweight and back to the casing, where it is secured. The lower end of the line carries the sinker. The counterweight is poised to hold the pointer at zero, but, when the sinker touches bottom, the weight descends until the line is drawn taut, thus causing the drum to rotate and the pointer to move over the dial and indicate the length of line left out and thus the depth of water. One of the revolving spindles is caused to actuate the clapper of a bell or gong through a lever, to give the alarm; or an electric circuit may be closed or broken to cause an alarm to be given in the officers' cabins. The sinker is held in position by a bracing line or chain extending to a windlass, by which means it may be raised out of the water when entering harbour &c. The sinker may have a tube for bringing up a sample of the ground touched, and the apparatus may be used for surveying the bottoms of seas, lakes, rivers, &c.

1592. Wallace, J. S., and Tucker, E.
April 13.

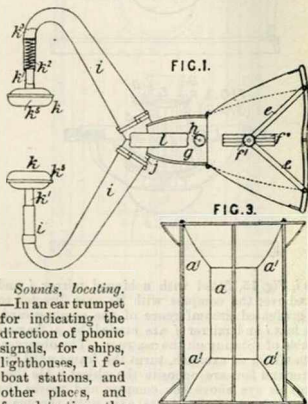

Sounds, locating.

—In an ear trumpet for indicating the direction of phonic signals, for ships, lighthouses, life-boat stations, and other places, and for detecting the existence or determining the direction of distant sounds, for military and other purposes, a trumpet-shaped receiver with parabolic or other shaped sides has a rectangular mouth a , Fig. 3, the lower sides a' of which are hinged so that the area of the mouth may be adjusted by links e , Fig. 1, which are fastened in the slot f by a nut f' . The mouth may be elliptical and its area varied by hinged or sliding doors. The receiver is detachable from the socket g , being



secured to it by screws h . Two ear tubes i are secured to the back of the socket by bayonet joints or other detachable fastenings. A diaphragm of skin or other material may be placed in the mouth to intensify the sound. The ear-pieces k are rendered adjustable by springs, fitting between flanges k^1 in the ear tubes, and collars k^2 on the tubular shanks of the ear pieces. Flanges, furnished with stuffed india-rubber or other cushions k^3 cover the ear and exclude local sounds; or ear-tips which enter the orifice of the ear may be used. The instrument is held by a handle l or may be pivoted by a ball-and-socket or other connection on a stand. The instrument may also be arranged with one ear-tube, provided with a pad on a spring clip or other device for closing the other ear. In all cases, the receiver projects forward before the face, so that the observer looks in the direction of the sound. Each instrument is provided with a set of receivers of different shapes and dimensions. In a modification, the trumpet mouth and tubes are made in one piece. A separate mouth may also be provided for each tube; or a cylinder into which the head is introduced may be used.

1598. Pastorelli, F. J. April 15.

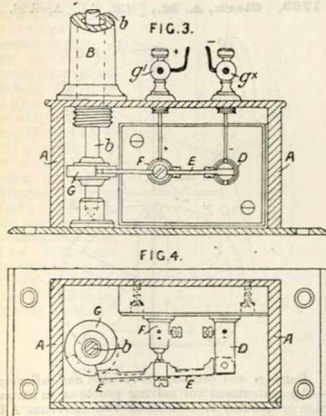

Anemometers.—An apparatus for measuring and indicating the velocity of air currents in mines and in chimneys and ventilators consist of four windmill vanes or hemispherical cups, which are mounted on radial arms projecting from a vertical spindle b , Fig. 3, so that they may be rotated by the air current. The spindle b passes through a hollow column B into a metal box A , and is there supported by a footstep bearing and carries a cam G against which the free end of a horizontal

pivoted lever E , Figs. 3 and 4, bears. Two insulated binding-screws g^x, g^1 above the lever E are connected, respectively, to an insulated pillar D on which the lever E is pivoted and to an insulated pillar F carrying a platinum point, against

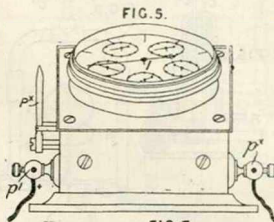
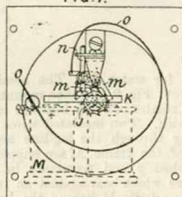

FIG. 7.



which a platinum point on the lever E makes contact when the free end of the cam G . The cam may be replaced by an eccentric or by a pin and spring. Wires connect the binding-screws g^x, g^1 to the binding-screws p^x, p^1 , Fig. 5, of the indicating-instrument, which may be placed in any convenient position; an electric battery &c. is placed in the circuit formed by the connecting-wires and instruments. At each revolution of the anemometer spindle, an electric current passes through the electromagnet M , Fig. 7, of the indicating-instrument, so that the armature K is moved towards the magnet. The spindle n of the armature is connected to a crank attached to the axis of a double pawl or pallet m , so that a ratchet-wheel J in connection with the pointer I , Fig. 5, of the indicator is driven one tooth forwards at each revolution of the anemometer spindle. Other pointers which indicate tens, hundreds, &c. are driven from the ratchet-wheel J . The armature and pallet are restored to their normal positions by a spring o attached to a projecting bar on the pallet. A commutator provided with a handle P^x is used for disconnecting the battery when the instrument is not in use. The ratchet-wheel J may be worked with or without clockwork mechanism, or it may be dispensed with and the motion obtained by means of permanent magnets or electromagnets or by means of cells, coils, or spirals, which convey an electric current acting

directly or indirectly on the pointers of the instrument.

Logs; current-meters.—The apparatus may be modified to serve as a ship's log or a current

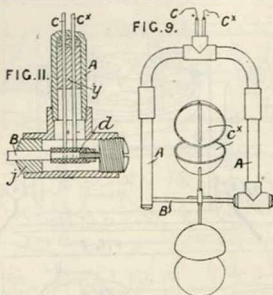

meter for water &c. The hemispherical cups or vanes C^x , Fig. 9, are then mounted on a spindle B which rotates in ivory bearings in a bent frame A, as shown. Two insulated wires C, C^x , Fig. 11, passing through the log-line and the right-hand limb of the frame A, are supported in an insulating-bed y and terminate in spring platinum pressers which bear against an ivory &c. ferrule d on the spindle B behind the bearing j . At each revolution of the spindle B, the wires C, C^x are connected through a flat metal plate into the ferrule d , and the indicating-instrument already described, being connected to the wires C, C^x , is thus actuated as in the case of its application to the anemometer. In another log or current meter, a counter placed on the frame A at one end of the spindle B is driven directly by this spindle and records the number of revolutions.

1720. Schumacher, G. W. April 22.

Thermometers.—Relates to a high and low temperature registering thermometer operated by the expansion and contraction of two corrugated india-rubber arms. One of the arms a , Fig. 1, is fixed at the upper end by a set-screw e to a projection f of the back plate j , and the lower end is connected to a lever d , Fig. 2, pivoted at l behind the scale-plate g . The long arm of the lever d is connected to the second india-rubber arm b , which is attached to a lever k fitted to a sleeve provided with a long pointer h . The indicator h is set to zero by the set-screw e . A spring m is used to push the indicator up the scale in order to keep the india rubber in a state of tension as it expands. Two movable pointers s placed on a curved rod n or otherwise in front of the scale, are moved along by the indicator h to record maximum

and minimum temperature in any interval of time.

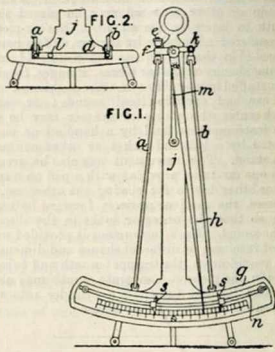

1763. Clark, A. M., [Hill, T.] April 26.

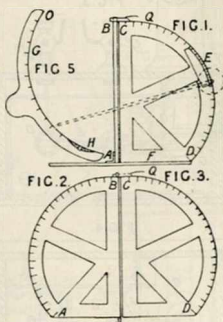

Bearings and courses, determining and indicating.—An instrument for solving problems in navigation or geodesy is formed of two meridians AB and CD of equal radius, one marked latitude and the other declination, and hinged together so that one of them can move over a sector plate F marked hour angle, the other being fastened to the plate, as shown in Fig. 1. The declination meridian bears a vernier E carrying a steel pin at its vernier point. Both meridians are graduated from the pole Q down to thirty degrees below the equator at A and D. An arc of altitude G, Fig. 5, of the same radius as the meridians is provided, which is graduated from two degrees below the horizon



at O to the zenith H and bears at its zenith point a compass card having a central hole to fit the vernier pin. The use of the instrument is to solve the spherical triangle which is formed when the zenith point H is placed upon the pin of the vernier E and the altitude arc laid across the latitude meridian. All the principal problems of navigation relating to time, latitude, longitude, azimuth, and great-circle sailing may be solved by means of the instrument. For great-circle sailing, the meridians are clamped at an angle equal to the difference between the longitude of the ship and of the desired port, the vernier E is placed on the declination meridian at the ship's latitude, the zenith of altitude is put upon it, and the altitude arc laid over the latitude of the desired port; the compass card now indicates the course, while the co-altitude is the great circle distance.

1868. Negretti, H., and Zambra, J. W.
May 3.

Specific-gravity estimating-apparatus; saccharometers.—Hydrometers, saccharometers, and similar instruments are strengthened against rupture at the neck, by a tough-glass or other tube D, Fig. 1, by a tube of stiff paper on which the scale may be marked, or by a wooden rod, or a reed, round which the scale is wrapped. Or, as shown in Fig. 2, the stem may be made separate from the bulb, and connected to it by a solid or tubular piece D of platinum or other metal.

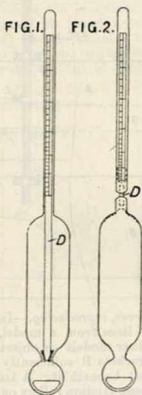

1894. Fenby, J. B. May 5.

Pantographs.—Relates to pantographic apparatus for engraving, carving, piercing, fret-cutting, &c. Fig. 1 shows a plan of an apparatus which is fixed to a metal table, grooved at w to receive an adjustable block w^2 , about which the parts move. The apparatus consists of two pantographic frames. One frame is horizontal and consists of the bars k , l , m , and n ; the other is vertical and consists of the levers 8 , r and s . The horizontal frame is supported on pulleys y^a and 4 and on adjustable sliding supports p . The article to be copied is placed at h , and the article to be cut or engraved on a reduced scale is placed

at i . Each is supported on a plate which is graduated of vertical adjustment and is graduated at the periphery. To facilitate the execution of alto-relievo work, the plate is made to tilt or rock and

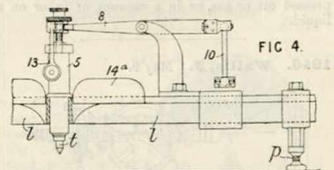
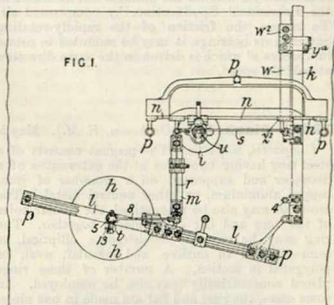

can be secured in any position by catches or set-screws. The two plates may be geared together under the table so that they move together. The tracer t is movable in a cylinder 5 connected to the bar l , Fig. 4, and actuates one end of the lever 8 the other end of which is connected by a universally-jointed rod 10, to the lever r , Fig. 1. The lever r is coupled to a lever s jointed to a bracket 2^a on the bar n . The fulcrum of the lever r is adjustable to allow the amount of vertical reduction to be varied. The tracer can be manipulated by a thumb-lever 13, Fig. 4, without taking the hands off the actuating-pads 14^a on the bar l . The drill or cutter u , Fig. 5, rotates in bearings in

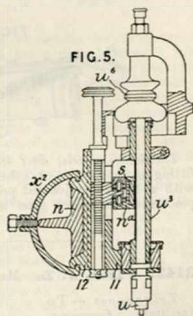

a slide 11, which is movable vertically in a block 12, adjustably secured by a bow x^2 to the bar n . The bar s passes through a block n^2 which is adjustable with regard to the slide 11. The cutter is driven by a belt on the pulley u^2 or, as stated in the Provisional Specification, by compressed air. To reduce the friction of the rapidly-rotating cutter in its bearings, it may be mounted to rotate in a sleeve u^3 which is driven in the same direction at half the speed.

1903. Clark, W., [Duchemin, E. M.]. May 5.

Compasses, magnetic.—The magnet consists of a steel ring having two poles at the extremities of a diameter and supported on a cross-bar of iron, copper, aluminium, or other neutral metal. The cross-bar may also be magnetized, the similar poles of the ring and bar being placed together. The ring may be circular, semicircular, elliptical, or semi-elliptical in outline, and circular, oval, or polygonal in section. A number of these rings placed concentrically may also be employed. In some cases, the ring and bar are made in one piece. The magnet may work in air or gas, or in compressed air or gas, or in a vacuum, or in or on a liquid.

1946. Wallis, J. May 9.

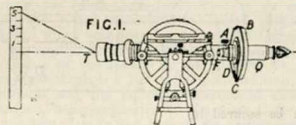
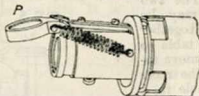

FIG. 3.



Theodolites, levels, &c.; telemeters.—Consists in fitting a theodolite or other similar instrument with a hinged or jointed prism between the eyepiece and the object glass to enable it to be used

2142. Field, J. L. May 20.

Telescopes.—To facilitate focussing, hand telescopes are constructed with rotary eye-pieces e and with one of the draws or tubes made adjustable by means of a

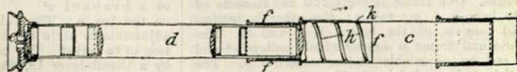

for measuring and ascertaining distances. Figs. 1 and 3 show an instrument called the "Euperimeter," in which the prism P is placed between the eye-piece Q and object glass T and fixed to a graduated disc B capable of being rotated by a nut C and screw D . The prism is hinged, as shown in Fig. 3, so that it can be placed in or out of the optical axis of the telescope by rotating an eccentric pin A . Springs are provided to hold it firmly in either position. The position and refractive power of the prism P are so designed with respect to the magnifying power of the telescope that each foot on the levelling-staff S shown between the two positions of the diaphragm wire, obtained by turning the prism through 90° , represents 100 feet in distance. Other scales are marked on the disc B indicating different proportions between heights and distances.

2101. Duthie, R. May 18.

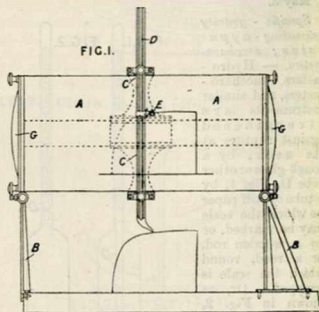

Curves, reproducing.—In order to draw or set out ships' lines from a model, or the lines and curves of other models or objects, a board A is mounted on brackets B sufficiently high to allow the model to rest beneath it. A tracing-bar D which moves between friction rollers on a carriage C is sharpened below to rest on the model, and carries a pencil E for tracing the curve on paper secured to the board A by clamps G . The carriage C travels without friction along the board.

helix or screw. In the telescope shown, the last draw *d* is made adjustable by means of an interposed tube *f* having a helical groove *h* in which engages a pin or helical piece *k* on the tube or draw *c*. After the telescope has been drawn out in the ordinary way, the tube *d* is rotated to adjust the focus.

2192. Cochrane, W. May 24. [*Provisional protection only.*]

Surveying-instruments.—Relates to improvements in surveying-instruments to render them self-recording and so dispense with the use of a protractor in plotting the surveys. As applied to a circumferenter, an annular table covered with a ring of paper &c. surrounds the dial case, and to its outer edge is affixed the usual back and fore sight. The dial case is provided with a folding arm carrying an adjustable double-pointed pricker or marker, which is capable of describing a vertical arc over the dial face, "and if the marker be pressed downwards before the commencement" and at the termination of its journey two impressions "pressions would be left on the annular table." The angles thus marked on the paper can be transferred to the drawing without the aid of a protractor.

2208. Dunn, W. W. May 25.

Tripod and like stands.—A stand for a rock drill has three adjustable legs *t*. The square cross-bar *t'* carries a round boss *t'*, on which is secured the socket *t'* by means of the clamp *t'*. The socket *t'* receives a trunnion on the drilling-machine.

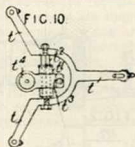

2227. Bagot, A. C. May 27.

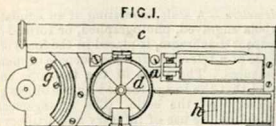

Clinometers; levels; measuring horizontal angles.—Levels, heights, horizontal angles, or angles of any inclination or depression are taken with accuracy and facility by fitting to the upper limb of a clinometer a reversible telescope and to the lower limb a prismatic compass with a telescopic sight. The instrument, which is shown in Fig. 1, is particularly serviceable in the construction of

drains. The telescope *c*, secured to the upper limb of the limb *a*, is fitted with reversible telescope arranged to swivel in a plane parallel to the surface to which it is connected. In using the instrument for taking the altitude of any object, the length of the base line is first determined, and the lower limb is set horizontal by means of a spirit level. The upper limb is then raised until the object is sighted through the telescope, and the angle of inclination is read off on the arc *g*. The altitude is then calculated from a table *h*, which is inscribed on the instrument and gives the rise corresponding to the angle; or the arc *g* is provided with a scale which enables the altitude to be read off as rise in inches per yard. The prismatic compass *d* affords facility for measuring horizontal angles in connection with the telescope and the graduated arc of the instrument.

2267. Barker, F. May 30.

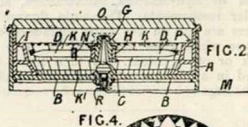

Compasses, magnetic.—The pocket compass shown in Fig. 2 may be used either as a mariner's floating-card compass or as a needle or land compass, the floating-card being made removable for this purpose. The case or box *A* has a glass bottom *B* ruled with radial lines corresponding to the points of the compass and carrying at the centre the pivot *C*. The needle *D*, consisting of a round steel wire with pointed ends and having one or more adjustable brass weights *N* to compensate for magnetic dip, is formed with a central eye *H* fitted tightly over the boss *G* so as to turn stiffly and enable the relative positions of the needle and card to be adjusted. This adjustment is effected by the aid of a graduated semicircle on the back of the card, the zero point corresponding with the North point on the face. The card indicates the true North, and is provided with a nut or socket fitted on the central boss *G* of the needle. The North point of the card is marked in a black colour in a white space on the black half of the card, as shown in Fig. 4, and the South point in a white colour on a black space on the white half, this method of marking being more particularly applicable to "Singer's Patent compass card." The glass cover *O* of the case is made removable to give access to the interior, and its bezel, which can be turned round or adjusted, carries a pointer *P* for reading off the variation on a graduated

circle I level with the card. By placing the compass on a map or chart, the bearing or direction of any point may be read off. To enable the bearings of any place on the map or chart which is beyond the reach of the compass to be ascertained, a fine thread M is attached to the centre of a small button R fitted in a socket in the pivot C; or, in place of the thread, a rod fitted or applied to the same centre is used. The ring K within which the needle moves is also marked with the points of the compass, and the bevelled ring K' is graduated in degrees for use with the thread M. The needle D is preferably electro-gilded.

2452. Guanzirolli, J. L. June 14. [*Provisional protection only.*]

Specific-gravity estimating-apparatus.—Relates to a method of fixing and protecting the indicating-scales of hydrometers, salinometers, and other similar instruments. The scale figures and characters are cut on the outer surface of a tube of opaque white glass and filled in with chemical black or other colour, the tube being then enclosed in a transparent stem hermetically sealed at the top.

2492. Ritchie, E. S. June 15. [*Provisional protection only.*]

Compasses, magnetic.—In a mariner's liquid compass, the magnet consists of a series of steel rods or wires secured in a parallel pack by a closely-fitting water-tight case. A divided ring is fastened to the magnets, two or more of which are used, and also to two or more arms extending from the magnets. Inside the ring is fitted a concentric spheroidal or bell-shaped buoyant vessel, within which is a hollow cone provided with the pivot bearing at its lower end. The magnets pass through or partly through the buoyant vessel, while around it and between it and the ring are openings to allow free passage to the compass liquid. The ring may be flat or inclined, or a perforated disc may be substituted for it.

2589. Normanville, W. de. June 23.

Logs; current meters.—Ships' logs or speed indicators, which may also be used to measure the speed of flow of streams, are constructed so that the speed may be continuously read off from a dial. A screw or rotator is connected by a tow-line to a universal joint b' on a shaft b fixed to a shaft c. The shaft c carries a disc c' bearing against a pair of friction discs d, to relieve the strain, and it imparts motion through a train of wheels to an axle i carrying pivoted arms k weighted at their ends and connected by links l to sliding collars m. When the axle i rotates, the balls fly out and move the collars m against the pressure of the springs n; one of the collars carries a flange m' which moves

a quadrant lever o, o' and actuates, through a cord or chain, an index finger g moving over a graduated dial. A spring g is interposed in the train of wheels to form a compensating-arrangement and

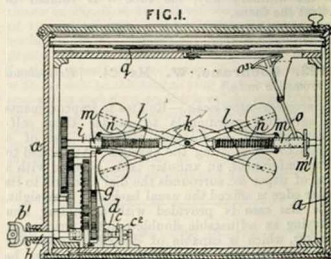

prevent sudden changes in velocity. The mechanism is contained in a cast-iron box a having a glass cover and a hinged lid, and fitted with a removable bottom to which the mechanism is fixed.

2658. Wise, W. L., [*Klinckfus, W.*] June 28.

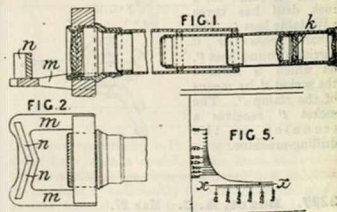

Telemeters.—A scale, consisting of an equilateral hyperbola engraved, photographed, or formed on a transparent diaphragm, is placed in the focus of the eye-piece of a telescope, for the purpose of measuring distances. The parts of the telescope are so arranged that the image formed by the object glass falls exactly on the scale. The arrangement is applicable for the use of infantry and artillery and for nautical purposes. Fig. 1 shows the telescope fitted with the scale k, and Fig. 5 an enlarged view of a scale for land purposes. The hyperbola shown is plotted with the image magnitudes of a man on horseback, height 275 metres, as ordinates, and with the distances as abscissae, the product of the two being constant. In order to measure the distance of a man walking or standing in the upright position, supposing that distance to be 500 metres or more and that the scale is plotted for the

image magnitudes of a man standing upright, the image of the feet of the man is brought into contact with the axis of abscissae, which is horizontal, and that of his head into contact with the hyperbola; the corresponding abscissae read off below gives the distance. If the distance is less than 500 metres, then in order to obtain greater accuracy, a line x parallel to the axis of abscissae is arranged to touch the head of the man; this line leads to a number on the axis of ordinates giving the distance. For nautical purposes, a ball-and-socket joint is placed between the telescope and its stand, and the rocking motion is followed by hand until the sea horizon is brought into coincidence with a line marked on the scale; the place at which the water line of a distant ship appears then gives the distance. To measure the distance of the ship at any other time, the hyperbola corresponding to the image magnitudes of an arbitrary vertical line on the ship, such as the mast, is found from a system of the hyperbolas by bringing the line into the system and making its image magnitude the ordinate corresponding to the abscissa representing the distance as found above; the upper end of the line then falls on the hyperbola required. A system of ten hyperbolas is employed, numbered 1 to 10, and the distance between them can be divided, by inspection, into decimal parts. When the land is in the background of the distant ship, the sea horizon is found by the aid of two mirrors n , Figs. 1 and 2, placed a short distance from the object glass on a bracket m . These mirrors reach to the axis of the telescope, leaving one half of the object glass to receive direct rays of light and the other half to receive reflected rays. By rotating the telescope about its longitudinal axis, the images of the horizon, which are reflected right and left from behind, are brought into line, thus forming an artificial horizon. For rapid surveys, the distance measurer is combined with a prismatic compass. With these a survey is made round any object visible, such as the spire of a tower, on which any arbitrary dimension is chosen.

The actual scale of the plan laid down in the VIRTUAL MUSEUM afterwards by measuring the arbitrary dimension.

2697. Adie, P. June 30.

Surveying-instruments; theodolites; tripod stands.—The three levelling-screws E, F, G of astronomical and surveying instruments are fixed to the tribrach A instead of working through it, and are adjusted by screw sockets C which are formed with ball heads resting in V -grooves in a tripod or frame underneath. Fig. 1 shows the application to a theodolite or like instrument. A locking-plate prevents the lower ends of the sockets from falling out of the grooves.

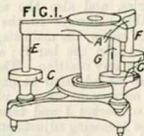

2817. Couper, J., and Richardson, W. H. July 11.

Lenses.—Prismatic lenses are formed with the several prisms B, C, D , surrounding the central convex portion A , of a gradually-increasing depth or thickness from the centre outwards.

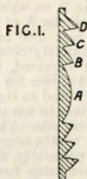

2962. Clayton, N., and Shuttleworth, J. July 21.

Plumbing-instruments.—Relates to an appliance which is used in levelling portable machinery, one being placed at each end of the machine. In the arrangement shown in Figs. 1, 3, and 4, a pair of brackets b, b' are secured in convenient positions, one over the other. The upper one has a tapered hole, Fig. 4, to receive the knotted end of the plumb-line a , and the lower one has a larger hole f^1 , Fig. 3, through which the line passes. When not in use, the bob is placed in a hole h in the lower bracket. A slot may replace the hole f^1 in the lower bracket. In a modification, the line is attached to a pin f^2 , Fig. 7, in the upper bracket, and hangs in a notch. A projection f^4 , Fig. 8, in the lower bracket serves as a centre for the bob, which, when not in use, is hung on a hook h , Fig. 5.

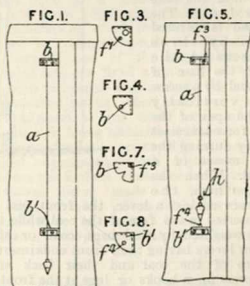

3078. **Stuart, J.**, [Zentmayer, J.]. Aug. 1.

Microscopes.—The sub-stage B, carrying the illuminating and polarizing apparatus and other accessories, and also the mirror, if required, is adjustable sideways to the right or left, either above or below, the main stage plate C, on a sleeve or socket I, in the bar S: a screw J clamps the socket in any position. The main stage plate C may also be adjusted at any angle with the axis of the microscope on the pivot O' turning in the sleeve or socket I and terminating in a screw c. The fine focussing adjustment may be obtained by a slide E pressed downwards by a spring G, the body being raised or lowered by the fine adjustment screw acting by means of the lever H on the slide E.

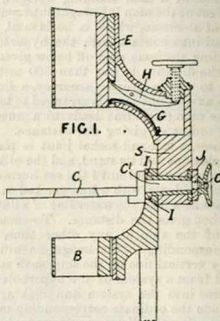

3152. **Gowper, E. A.** Aug. 9.

Tripod stands.—A cradle *g*, Fig. 3, on which the drill cylinder *h* of a percussive rock drill for cutting horizontal grooves in coal is mounted, is pivoted to the rear leg *c* of a tripod stand so that the cradle may be moved from side to side. The legs *a*, *b*, *c* of the tripod consist, preferably, of wrought-iron tubes having solid ends united by welding, screwing, or other means, and are connected near the base by tie-rods *d*, *e*, *f*. The tripod stand is secured in position by three pointed screws at the corners of the base of the stand and by a screw *z* passing vertically through the apex of the stand and forced against the roof by turning the screw by means of a hand-wheel. When the roof is too high, the screw *z* bears against a lever, the front end of which is inserted in the face of the coal while the rear end is weighted by sand bags, coal, or other weights; or levers having their front ends inserted in the face of the coal and their back ends weighted press upon hooks or lugs at the front of the frame, the back corner of the stand being in this case kept down by weights laid on bars hooked on the frame and on the levers. When the rock drill is used for cutting vertical grooves, the top

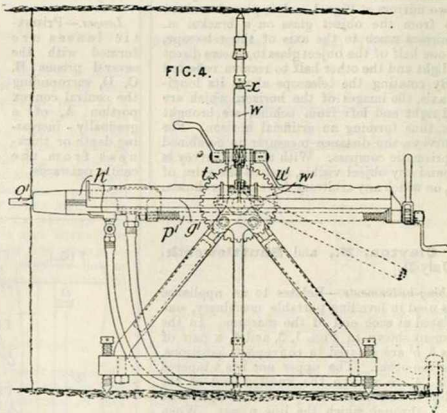

of the tripod is provided with a socket for the reception of a movable hollow post *w* fitted at its upper end with a screw *x*, the pointed end of which is forced against the roof. In another method of fixing the tripod, lugs *w'* are formed at the top of the tripod for the reception of a movable strut extending backwards and provided with a pin which can be driven into the floor of the working. A lever which is inserted at one end into the coal and is weighted at the other end

bears on the tripod just below a trunnion on the cradle, or two similar levers press down on the side of the bottom of the frame in order to secure the tripod.

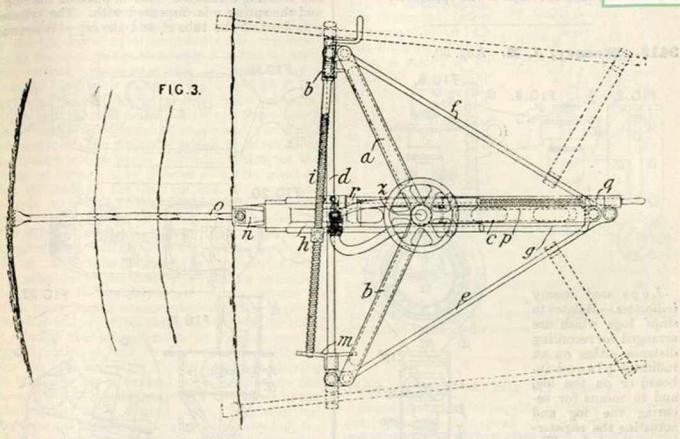

3163. **Byrne, F. W.** Aug. 10.

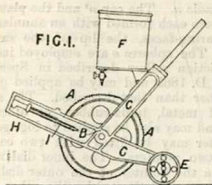

Ground markers for marking streets and open places when surveying &c. A rough disc A of stone, cast iron, &c. is mounted in a fork or frame C having an inclined handle and running on a pair of rollers E at the ends of a transverse axle. Above the disc is mounted a water can F, and in a trough or slide in front of the disc is placed a piece of prepared chalk, pipeclay, or other marking material or pigment, which is pressed against the disc by a plate H and springs I.

3187. **Follows, F. W., and Bate, J.** Aug. 12. Drawings to Specification.

Wind vanes.—Bearings for the spindles of weather vanes are made of agate.

3224. **Wolchoff, A. D.** Aug. 16. [Provisional protection only.]

Dividing-engines for cutting scales and the like.—Relates to machinery or apparatus for marking divisions upon curved, flat, or other surfaces, which apparatus is especially applicable for marking or dividing scientific instruments. Divisions of various dimensions are marked upon several articles at one operation. The objects to be divided are carried by slides travelling in guide frames fixed to a base-plate, which slides are operated from rotating segmental wheels across the diameters of which travel studs or crank-pins coupled by connecting-rods to the slides. The periphery of one of the segmental wheels is "divided into one fixed standard" to enable the apparatus to operate uniformly by the intervention of a toothed ratchet wheel and lever, "and without adjustment for each series of divisions required, it being understood that the projecting studs or crank-pins are capable of diametrical or radial adjustment, which adjustment at once defines the various dimensions of divisions, such divisions being made of travelling knives, needles, circular cutters, or other instruments attached to oscillating levers moving upon transverse slides, and acting simultaneously."

3301. **Browne, A.,** [Chaumette, A., Delpêche, J., and Posty, J. B.] Aug. 22. Drawings to Specification.

Barometers; thermometers.—The upper part of

a memorandum tablet or stand for commercial use fitted with a barometer, &c., and a thermometer is placed between the flaps of the apparatus.

3412. Massey, J. E. Aug. 30.

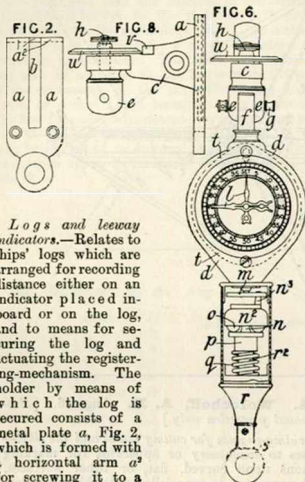

Logs and leeway indicators.—Relates to ships' logs which are arranged for recording distance either on an indicator placed inboard or on the log, and to means for securing the log and actuating the registering-mechanism. The holder by means of which the log is secured consists of a metal plate *a*, Fig. 2, which is formed with a horizontal arm *a*² for screwing it to a horizontal rail and with a vertical slot *b* into which a vertical flange on a stand *c*, Fig. 8, fits. The plate *a* may be screwed to a vertical post, the arm *a*² being then dispensed with. In order that the log-line may be inclined freely in any direction, the head *f*, Fig. 6, of the registering-apparatus to which it is connected inboard is pivoted on a horizontal pin *g* to a vertical conical metal stud *e* which turns in the outer end of the stand *c* and is secured by a nut *h*. The head of the stud *e* may carry a dial *u* and the stand *c* a pointer *v*, or *vice versa*, the combination serving as a leeway indicator. In order to lessen friction at the registering part of the apparatus, the spindle *n*, on which the ring *S* for the line is formed, is formed at its inner end with a cap or bearing *n*² for spheres *o* which are also pressed upon from below by a hollow cylinder *p* and a spring *q*. The spring and cylinder are placed round the central tubular part *r*² of a cap *r* which screws into the register case *d*. A crank-pin *n*³ on the cap *n*² engages with and drives a disc *m* on the shaft carrying the worm whereby the registering-wheels and pointers *l* are driven. The shaft *n* may be turned down or grooved under the cap *n*² to facilitate the action of the spheres *o*. When the arrangements described are applied to harpoon

and other logs which register by means of mechanism applied to the rotator or log itself, the rotating blades are fixed in place of the ring *s* and the spring *q* is dispensed with. The cylinder *p* is fixed to the tube *r*², and the cap *n*² is screwed

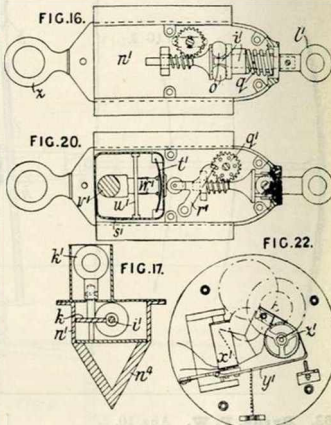

on the spindle *n*. The cap *n*² and the plate on the cylinder *p* are each formed with an annular groove in the bearing-faces, the lip of the cap being removed. The spheres *o* are employed instead of the antifriction rollers described in Specification No. 233, A.D. 1865, and may be applied generally to logs other than that described. The spring *q* may be of metal, india-rubber, or other elastic material, and may also be applied to logs generally. The register may be fitted with two concentric dials and two pointers. The inner dial indicates miles, while the pointer of the outer dial rotates once for each mile indicated by the other pointer. The outer dial is divided into sixty divisions, each of which represents one mile per hour when the indications are read per minute. The dials are covered by a plate *t*. The outer dial may be dispensed with when the register is applied to logs which register outboard. In another arrangement of a log for registering inboard, the rotator is connected by a rope or directly to a ring *l*¹, Fig. 16, formed on the end of a horizontal spindle *l*², which projects into a flat case *n*¹, Figs. 16 and 17, and may be fitted with a spring *q* and spheres *o* as already described. The spindle *l*² carries a worm which drives a pinion *k* to a ring *k*¹ on which a vertical rope is attached. The case *n*¹ is submerged in the water under the vessel's quarter, and is connected by a ring *z* with a towing-rope attached to a spar projecting over the side of the vessel. The vertical rope from the ring *k*¹ passes up to a ring fastened to the vertical shaft of the first

wheel of the register, which in this case is fixed upon an arm supported as already described over the vessel's quarter. A V-shaped sinker n^1 is attached to the bottom of the case n^1 in order to submerge it. Electrical apparatus may be provided in the last-described arrangements for communicating the rotation of the spindle i^1 to the register. The vertical rope in this case is replaced by a piece of telegraphic cable v^1 , Fig. 20, which at the lower end passes into a water-tight case s^1 of india-rubber and the wires w^1 of which are there bared, passed through an insulating support u^1 , and coiled into springs. The pinion q^1 which is driven from the rotator carries on its face pins, which, as the pinion q^1 rotates, turn a lever r^1 on its pivot so that the end of the flexible case s^1 is pressed inwards to connect the heads of the circuit-wires w^1 by means of the metal spring p^1 . The wires w^1 are connected at their upper ends to an electric battery and an electromagnet x^1 , Fig. 22. Each time the circuit is completed, a lever y^1 is attracted to the magnet x^1 and on springing back moves the ratchet-wheel z^1 , by means of which the motion is communicated to the register. The electrical apparatus may otherwise be modified by placing the arrangements of flexible case s^1 , Fig. 20, pinion q^1 , and lever r^1 in a case inboard over the case shown in Fig. 16, and then driving the pinion q^1 by a vertical rope attached to the pinion k . The register may then be placed in the cabin or any other desired place. The electrical arrangements may also be applied to any log, the whole arrangements of which, with the exception of the rotator, are inboard.

3417. Brice, W. A. Aug. 30.

Actinometers.

—An actinometer which is attached to a camera for determining the quality of the chemicals and the lens employed, and the quick or slow working of the plate, and for affording information as to the cause of fog in a picture, consists of a wooden frame A provided with a sliding glass plate B, to one face of which are fixed plates or sheets C of transparent material. The centre of the glass plate is left clear, and the number of superposed layers of plates C increases in regular succession towards the ends of the plate B so as to afford a greater obstacle to the passage of light. The actinometer is set up by means of hinges and hooks or screws between the lens and the sensitized plate, and the photograph is taken in the usual manner. The condition of the various sections of the picture, after being developed, indicates the quality of the chemicals, lens, and light employed.

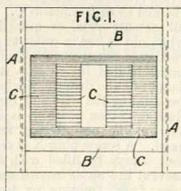

3432. Brice, W. A. Aug. 31.

Sounding-apparatus.

—The disengaging-gear described below in connection with boat-lowering apparatus, is stated to be applicable for taking soundings by attaching to it a weight which is automatically released on touching the ground. The ring D of the lowering gear is passed over the hinged piece C, which is jointed to the arm B and passes through a slot in the standard A. The end of the piece C locks against the top of the slot in the standard when the weight of the boat is upon it, but when the boat is water-borne, the lowering of the falls allows the piece C to slip through the slot and release the ring D. Fig. 3 shows the mechanism reversed, the ring D being connected to the boat chains.

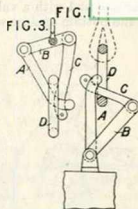

3452. Thomson, Sir W. Sept. 1.

Sounding-apparatus capable of being used without reducing the speed of the ship consists essentially of a narrow glass tube, which is closed at one end and is provided with a preparation for marking that portion of the interior into which the air originally filling the tube is compressed when the tube is lowered to the bottom of the sea. The tube is placed in a metal guard and is attached to the sounding-line above the sinker, or may be placed in the sinker, which is preferably a cylindrical iron bar of about three to four feet in length and from about one to one and a half inches in diameter; soap, tallow, or wax is placed in a hollow in the lower end of the sinker to bring up a specimen of the bottom. The interior of the glass tube is lined wholly or partially with white-wash, size, colour, ink, or aniline blue, the substance used being dried upon the inside of the tube; red prussiate of potash, potash mixed with starch, or other substance which is adapted to give the required indication by chemical action may be used. In the latter case, the substance may be caused to adhere to the glass or to a narrow strip of paper which is gummed or pasted to the interior of the tube. The outer guard or the hollow sinker may otherwise be filled with ink, aniline blue, sulphate of iron, or other suitable liquid which is then forced into the glass tube by the pressure of the sea-water outside the guard &c. The interior of the tube is coated with shellac varnish, glue, or gum to prevent the marking-liquid from running by capillary attraction beyond the correct point. A simple method of obtaining the required mark is to smear the mouth of the tube with oil or with lycopodium or other fine powder. The tube may be open at both ends, so that it may be dried out easily, and a stopper or plug is then screwed into a brass mounting on one end of the

tube when it is required for use. The guard *o*, Fig. 6, is provided with a removable cover *p* at its upper end and with a vulcanite or other elastic bar *r* at the bottom against which the open end of the

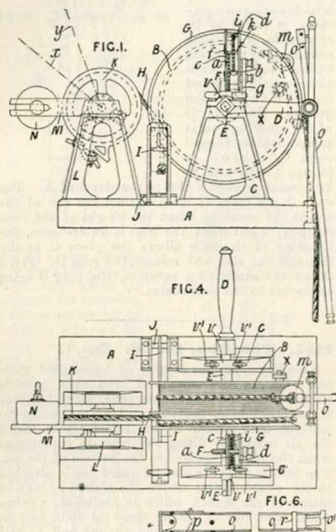

glass tube rests. The plug *o*¹ can be unscrewed when the guard *o* requires to be cleaned out. When it is desired to obviate the necessity of previous chemical or other preparation of the tube, the tube is open at both ends and is provided with an inward-opening valve at each end. Water enters at the bottom while the tube is descending, and air escapes at the upper end while it is rising, the effect being that, when the tube finally emerges from the water, it contains water and a quantity of air at atmospheric pressure occupying the same volume as the air compressed in the tube at the bottom of the sea. The danger of the tube bursting by internal pressure is by these means obviated. A scale graduated in fathoms according to the known law of compression of air may be attached to the guard-tube, or is placed in the chart-room &c. of the vessel. The tube and sinker may be let down in the sea by the ordinary method of taking deep-sea soundings or by means of the apparatus shown in side elevation and plan in Figs. 1 and 4. The pianoforte or other strong wire used instead of the usual rope sounding-line is coiled on a drum B which is supported in bearings *e* upon standards C fixed to a sole-plate A near

the stern of the vessel. The free end of the wire is secured to an iron ring or link *m* to which a short length of rope, carrying the sinker at its other end, is also attached. The guard-tube *o* is lashed to the rope with enough rope above it to make one turn round the drum, the object being to lessen the tendency of the wire to unwind itself. A cord H, which passes round a pulley G on one side of the drum B and is attached to a transverse pivoted and weighted lever I, is attached also to a pulley K which is supported in standards L and is formed with a lever M carrying a weight N. The cord H thus acts as a brake on the drum B. The shaft E of the drum carries a worm or tangent-screw F, by means of which the motion of the drum is communicated through a spindle *b* with a wheel *a* and pinion and a spindle *k* with a wheel *i* to two pointers *f*. This counter is mounted between two side plates *c, d* secured to an arm *g* on one of the frames C, and serves to indicate the number of revolutions of the drum B made in paying-out the wire. When the wire is running off the drum, the lever M is raised by hand to the position *x* so that the lever I turns on its pivot J and hangs freely between the stops which limit its motion. A constant retarding force is thus exerted on the drum by the cord H. When the wire stops running out, the lever M is dropped into the horizontal position, thereby raising the lever I against its upper stop and exerting a large frictional force on the drum. When the handles D are turned to wind up the wire, the lever I falls against its lower stop and the lever M is raised into the position *y*, little force being then exerted by the cord H on the drum. The caps of the bearings *e* of the shaft E are formed with slots leading out of the holes through which the tightening-screws *e*¹ pass, so that, when the screws *e*¹ are slackened slightly, the caps can be slid out of place and the drum B lifted from its bearings. The caps are preferably chained to the standards C. The drum is placed in oil, caustic soda, or quicklime in a closed vessel when not in use in order to prevent the wire from rusting. Fixed cheeks guide the wire when it is being hauled in, so that it is kept clear of the flanges of the drum. Mechanism may be provided for guiding the wire and for drying it by means of cloth or cotton waste as it is being hauled in, but the guiding and drying are preferably done by hand. A screw plug X is provided on the drum so that it may be filled with hot water, in order to prevent the water carried up to it by the wire and rope from freezing or to melt ice so formed. When a sufficient number of observations have been taken by means of the apparatus and have been tabulated, the depth of water may be reckoned from the record given by the counter.

3462. Brewer, E. G., [Facio, E. E. S.].
Sept. 2. [Provisional protection only.]

Compasses, magnetic; barometers; thermometers. —Relates to a method of lighting up compasses, barometers, thermometers, and other instruments, which method is described in connection with watches. The watch is united by a chain to a

link-bar which can be fitted in a buttonhole, and another chain communicates with an electric pile, which may be carried in a waistcoat pocket; a third chain communicating with a receptacle or box containing wick and a Geissler tube for transmitting "the spark produced by the electricity" is attached to the link-bar. The receptacle is connected to the pile by a button or other suitable appliance. The light-producing apparatus may be provided with a case for holding the watch or other article to be lighted up, or the apparatus may be carried by the watch itself.

3505. Heyer, H. Sept. 6. [*Provisional protection only.*]

Rulers.—The ruler consists of a bar of wood, having preferably a triangular section, and forming a cover or case for a roller situated in a groove in the bar and pivoted at both ends. The depth of the groove is such that as the roller travels over the paper, the edge of the cover used for ruling remains out of contact with the paper.

3526. Maw, W. H., and Dredge, J. Sept. 7. [*Provisional protection only.*]

Pyrometers.—A signalling-object is connected to the moving parts of a pyrometer or pressure gauge so that a signal is given on the attainment of a predetermined temperature. In one form of the signal, which is described with reference to a pressure gauge, a red disc is held by a detent behind the indicating-dial and above a central opening in it until the mechanism acts on the detent and allows the disc to fall and occupy the central opening. In another form, the signal disc, which may be in one or two pieces, is arranged to hide the entire dial when released. The release of the detent may otherwise render a signal outside of the case visible. Other signals may be employed instead of discs.

3658. Brice, W. A. Sept. 19.

Sounding-apparatus.—Apparatus for taking soundings at sea consists of a double bolt C or two separate bolts which are guided over a block A by means of a central stem and are caused to grip the block by the pull on the lines H, G due to the weight at the end of the sounding-line. When the weight touches the bottom, the bolts C fall and release the lines and weight.

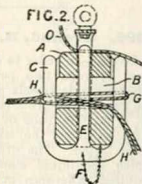

3705. Johnson, J. H., [Dion. Baylis, J.]. Sept. 21.

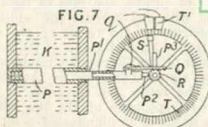

Pyrometers.—A pyrometer for indicating the temperature of a tempering-chamber K consists of a tube P¹ of brass, copper, or other metal, which is more expansive under heat than iron, secured in the closed end of an iron tube P passing through the chamber K. An iron or steel rod P² having a turned-up end P³ is screwed into the end of the tube P¹. A rack bar Q mounted upon the tube P¹ is kept in gear with a pinion R carried on the end P³ of the rod P² by a spring q; and a pointer S carried on the axle of the pinion R moves over a dial T. The tube P¹ being more expansive under heat than the rod P², the rack Q rotates the pinion R and moves the pointer over the dial.

3741. Neumann, G. H., [Weaver, W.]. Sept. 25.

Tripod stands.—The frame of a rock drill is mounted on three legs a², b, the two front legs a² being extensions of the side bars a¹ of the frame, to which they are secured by screws a³. The leg b is forked at its upper end and is pivoted to the side bars a¹. The length of the leg may be adjusted by screws.

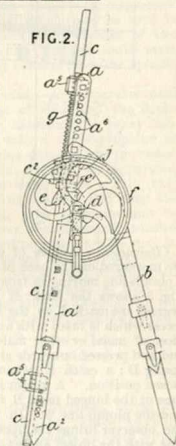

3780. McClean, F. Sept. 23.

Spectroscopes for use with telescopes. A concave cylindrical lens b is combined with a prism or prisms a and applied as the eye-piece of astronomical or other telescopes. The eye-piece is in adjustment when the concave lens is at the distance of its



own focal length inside the focus of the telescope.
 "In the direction of the axis of the lens and of the prism or prisms, the rays of light are not interfered with and produce the width of the stellar spectrum on the retina of the observer.
 "In the direction across the axis of the lens and of the prism or prisms the rays are rendered parallel and in that state are analysed by the prism" and form upon the retina the spectrum of the star.
 To compare the spectrum of the star with other spectra, the image of an illuminated point of light is thrown into the field of view along with the image of the star, and the two are analysed by the spectroscope simultaneously.

3856. **Smith, W.**, [Baldwin, P. B.]. Oct. 5.

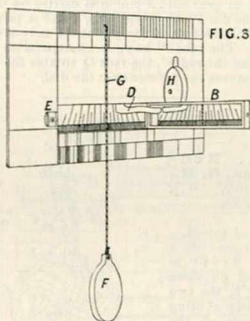

Clinometers.—Angles of elevation or depression are measured on the back of a protractor plate by a plumb-line moving in front of a scale of degrees. Fig. 3 shows the back of the protractor. The degrees are marked on the back of a rectangular piece which is fitted with a correspondingly-shaped piece of metal or other material B hinged at one end and pressed outwards at an angle of 45° by a spring D; a catch E retains the piece B in its closed position. A mirror is attached to the inner face of the hinged piece B for reflecting the scale and the plumb-line G. In using the instrument, the observer brings the upper edge of the plate in line with the object and at the same time reads the angle in the mirror. A scale of "shade" may also be provided for reading off the approximate angles of gradients and inclines at the same time as the angles of elevation or depression. H is an aperture for the reception of the plummet F when the instrument is not in use, the cord being wound round the plate.

3867. **Woodbury, W. B.**, [Wilson, E.]. Oct. 6. [Provisional protection only.]

Magic-lantern apparatus.—A disc of glass is revolved in front of a magic-lantern by means of two india-rubber covered friction-wheels which are driven by a third large wheel having a flat disc of india-rubber attached to its edge. A fourth wheel is attached to a spring to allow the discs of glass to be easily changed.

3970. **Kemp, R.** Oct. 13.

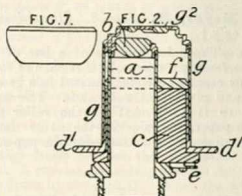

Microscopes.—An ordinary low-power lens b , Fig. 2, is mounted in a tube a . An eccentric c surrounds the tube and serves as an axis for a tube d' which is held in position by a disc f screwed to the eccentric. The tube is provided with a milled flange d' and a pin, stud, or screw projecting from its side. A tube g has a slot which fits over the pin and is made to turn with the tube d' . The tube g is provided at the end with a diaphragm which works close to the low-power lens. The diaphragm may have apertures of various shapes or lenses g' of different powers, any one of which may be brought central with the low-power lens by turning the milled flange. A spring catch e , working in conjunction with the flange and fitting into notches in the eccentric, ensures the correct adjustment of the parts. When a hollow cone of light only is required, the back of the lens is ground flat as shown in Fig. 7, the flat surface being blackened.

3996. **Ground, H. N.** Oct. 16.

Levels.—In order to determine the difference of level between two points, glass gauge tubes or other suitable vessels placed on two standards at the two points are connected at their lower ends by a flexible tube of india-rubber &c., and are filled to about the middle points with water or other liquid. The difference of the readings at which the liquid stands in the tubes gives the required difference of level. The readings are taken on suitable scales on the standards. In a modification of the instrument, the flexible tube is connected to short glass tubes or vessels which are movable vertically on the standards to bring the surface of the liquid in the flexible tube into a



visible position at each standard. The standards are of equal lengths. The principle may be applied to instruments of other forms than those described, and may be employed for finding the relative heights of several points.

4041. Beer, B., [*Peipers & Co., W.*]. Oct. 19.
[*Provisional protection only.*]

Camera obscuras for sketching &c. The object glass, which is a convexo-convex lens, is contained in a sliding tube fitted to the front of the dark chamber, and behind it a mirror is placed obliquely to reflect the rays of light through a sheet of glass forming the top of the chamber; a sheet of tracing paper or other like transparent material is placed over the sheet of glass. The lateral walls of the dark chamber are removable from the base-piece, and are arranged to fold to facilitate transport. A hood or shade with side flaps, and also capable of being folded, is fitted to the front of the chamber.

4056. Tylor, A., and Tylor, J. J. Oct. 20.

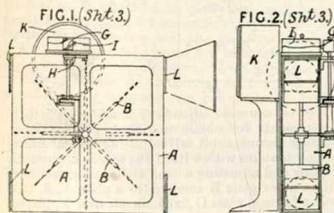

Anemometers.—A recording-apparatus which is stated to record the velocity of the air or other fluid which passes through the rotary meters described in Specifications Nos. 1008 and 1411, A.D. 1871, and No. 1391, A.D. 1872, [*Abridgment Class Rotary engines &c.*], consists of a governor D, Fig. 1^a (Sheet 2), which is driven from the vane-wheel of the meter and causes a pencil P to move parallel to the surface of a drum G, which is driven by a clock F. The drum G may otherwise be driven by the meter and the pencil moved by the clock, in which case the governor is dispensed with. An anemometer for use in measuring the velocities and quantities of air passing through ventilating-shafts, mines, or buildings, consists of a fan or vane-wheel B, Figs. 1 and 2 (Sheet 3), which is mounted in a box A so as to be driven by the air which enters at one or

other of the openings L, and to drive the drum G of the recording-apparatus. The marker consists of a helical ridge on a drum, which is driven by means of the gearing shown, and is pressed against the recording-drum I by a spring H. The drum I is covered with paper, and is driven by a clock K. To regulate or govern the action of the wheel B, a jet of water, steam, or air is caused to produce a counter or back current, as described in Specification No. 1411, A.D. 1871, the amount of which is regulated by an ordinary ball governor. The governor is driven by the anemometer and acts through levers, either on a plug-cock or on a gridiron slide-valve, so that the regulating current of air &c. is admitted to a greater or less extent according as the speed of the wheel B is excessive or deficient. The counter current may act on the wheel B or on a second wheel attached to it. The governor, or, according to the Provisional Specification, a magnet, may also be caused to lift or lower the marker in proportion to the change in the velocity of the wheel B. The apparatus is stated to record directly the quantity or velocity of the air passing through the passage in which it is placed. When the apparatus is used in collieries &c., the recording-apparatus may be placed above ground &c., and is connected to the anemometer by an electric or other suitable arrangement. Another form of register which may be used in connection with the anemometer consists of two index wheels, one of which has one tooth more than the other, driven by a worm from the spindle of the wheel B.

Logs; sounding-apparatus.—An apparatus used for measuring the speed of ships and the depth of water under a ship, consists of a heavy fish-shaped body provided with a screw-propeller or paddle driven by an engine actuated by compressed air, ammonia, steam, &c., so that the apparatus, when suspended in the water from a ship, may move at the same speed as the ship and keep the connecting-rope vertical. The apparatus may be arranged to stop or make a record when it touches the bottom. The connecting rope or cable may be wound on a drum or attached to a spar projecting from the ship's side. The rope may be connected to a dial, clock, or electric apparatus, so that the time taken for the apparatus to descend to the bottom, and the depth of water, may be permanently recorded.

4153. Cole, J. Oct. 26.

Spectacles.—For curative purposes, strips of magnetized steel are placed in parallel rows or otherwise between two thin sheets of cork which have been soaked in Stockholm tar thinned down with benzoline, and the covered magnets are laid between cloth, flannel, or other suitable material, the edges of the sheets being previously cemented together. The combination is made into spectacles and other articles. The cork covering may be omitted with leather-covered articles, and any other magnetizable metal may be used instead of steel.

4165. Abel, C. D., [*Ajfland, D., and Hadenfeld, E.*] Oct. 27.

Logs and leeway indicators.—In an apparatus for indicating the speed and leeway of vessels, a vertical tube R, constructed in lengths screwed together and fastened by keys f^2 , passes through a stuffing-box p in the ship's bottom at one side of the keel K and is formed with a funnel-mouth o' and vane n^1 , which set in the actual direction of the ship's motion and cause the tube R to turn. The tube R carries at its upper end a pointer k which indicates the leeway on a horizontal dial k^1 . A second pointer n^2 attached to a float n in the tube R indicates the speed on a vertical scale n^3 . The tube R is supported by a collar m in a bearing S' , and by a bearing S under a bevel-wheel or nut t which works on a screwed portion of the tube. When the tube requires to be raised, as when the ship is being docked &c., a bevel-wheel t' in connection with a winch is pushed into gear with the wheel t and is turned by means of the arrangement of float &c. may be omitted when an indication of lateral currents only is desired.

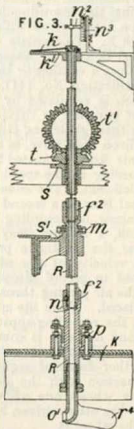

4186. Weldon, F. Oct. 28. [*Provisional protection only.*]

Range-finders.—In a modification of the range-finder described in Specification No. 1047, A.D. 1874, the sights on the bar and limb are replaced by reflectors such as are used generally in reflector instruments. One reflector is placed on the bar, and another on the limb. When a staff has been set up at the point at which the distant object and the point at which the instrument is to be used subtend a right-angle, the instrument is held by the operator and the limb moved so that the reflection of the staff is aligned on the distant object, or *vice versa*. The distance of the object is then obtained by multiplying the length of base by the number on the scale. The length of base may also be ascertained by the instrument. The tripod formerly used for supporting the instrument is dispensed with.

4243. Westinghouse, G. Nov. 2. [*Letters Patent void for want of Final Specification.*]

Logs; current meters.—In order to indicate and record the speed of a ship or of a current of water, a chamber is employed into which fluid from a reservoir in which it is maintained at a constant pressure is introduced. Fluctuations in the pressure of the fluid in the chamber are caused by the motion of an escape-valve operated by the flow of water past the ship &c., and are indicated and recorded to show variations in the speed of the current of water by a pressure gauge or other indicator &c.

4258. Watkin, H. S. S. Nov. 3.

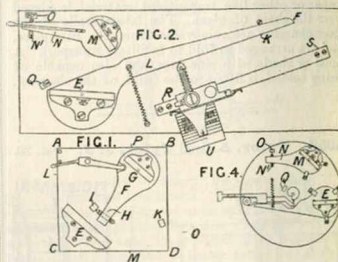

Optical squares; telemeters; sextants.—Relates to instruments for obtaining right-angles and ascertaining distances. A self-adjusting optical square which contains within itself the means of instantly testing and adjusting a true right-angle, is formed of an index glass E screwed to a plate A, B, C, D and a horizon glass G fixed on an arm F, pivoted on the plate and working between stops I, K. The end of the arm F is fitted with an adjustable screw H and the stops I, K are fixed so that the traverse of the arm is exactly 45°. When the arm F is pressed by a spring against the block I and the eye applied at L, the horizon glass may be so adjusted by the screw H that the image of a distant object as seen by double reflection and by direct vision is coincident. When the arm E is against the block K and the eye applied at M, objects O will be seen by double reflection, and those at right-angles to them by direct vision in the direction P; thus an optical square is produced, which admits of adjustment to an exact right-angle. "This method can be applied with equal facility to the index glass, and also to non-reflecting instruments." This principle of construction may be applied to the common sextant, thus enabling angles to be read up to 180° or more if required. Fig. 2 shows a range-finder constructed on the same principle. The horizon glass M is carried by the arm N, N' moving between the stops O, Q, and the index glass E is carried by the arm E, F which is pivoted at E, the prolongation of the side K, L of the arm passing through the

pivot. A base bar R, S is fixed to the bed-plate and along it moves a slide carrying a conical-pointed screw acting against the arm E, F. The head of the screw carries a boxwood cylinder U on which is marked a spiral scale of ranges, or degrees and minutes, for a base of, say, 100 yards, an index finger being fixed to the slide. The base bar may be graduated so that the scale U may be used for bases of from 50 to 130 yards by moving the slide along the base bar. When the screw is turned, the arm E, F with the index glass E is moved through an angle which is indicated on the scale. In another form, the graduated base bar is pivoted and acted on by the screw, which works through a block fixed to the bed-plate. The method of working the range-finder is described. For long ranges and obscure objects, a telescope is provided. The same instrument can be adapted for infantry and naval use, and it may take the form shown in Fig. 4, a cam being used in place of a screw, a pointer on the cam spindle moving over a dial graduated in yards.

4299. Moser, A. Nov. 6.

Telescopes; angle-measuring instruments.—Relates to telescopes used in geodetical and astronomical instruments for measuring angles, such as theodolites, telemeters, and the like, and consists in the application of prisms for measuring small angles by means of refraction. Two prisms *e, f*, carried by a tube *h*, are placed in front of the objective of the telescope, one prism *e* being fixed while the other *f* is connected to a worm-wheel *i* rotated through a worm *h*. The wheel *i* is divided into degrees and it is moved through one degree by each rotation of the worm *h*, which carries a graduated disc *l* divided into 60 parts and fitted

with a vernier *m*. The prisms are made of different refractive power, say 30 minutes, so that when acting in opposition the result is zero and when acting together the total refraction is one degree.

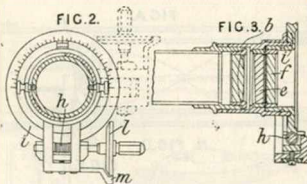

Any degree of refraction is obtained by rotating the prism *f*. To measure the angle between two objects, the prisms are placed at zero and the telescope is trained on one of the objects; the prism *f* is then turned until the cross-hairs cover the second object, the versed sine of the angle read off from the graduated dials giving the angle in seconds. The tube *b* is mounted so that it can be turned through a right-angle, as shown in dotted lines in Fig. 2, to enable vertical angles as well as horizontal angles to be measured. The prisms may be placed between the eye-piece and the objective.

4310. Newton, H. E., [Boucher, A. E. M.].
Nov. 7. Drawings to Specification.

Compasses, magnetic; barometers; thermometers.—A compass, aneroid barometer, or thermometer may be placed in the vacant space at the centre of a circular slide-rule for pocket or office &c. use.

4330. Visino, T. Nov. 9.

Courses, plotting; logs; compasses, magnetic.—In an apparatus, shown in elevation in Fig. C^x and in sectional plan in Fig. C, for plotting the course of a ship, the disc 16 carrying the tracing-pencil 17 is moved across the paper on two bars 14, 15 by a screw 9. A disc M placed at one end of the bars carries clockwork *i* for turning the screw 9, and also an electromagnet which is excited at intervals from an electric log, in order to set the clockwork in motion. The bars 14, 15 are made to follow the movements of a compass needle, placed above them, by means of clockwork *h*, which is also set in motion by one or the other of two electromagnets 7, 8. A wheel 5 in connection with the clockwork *h* moves the wheel L, on the axle of which the bars gyrate, in one direction, and the wheel 6 moves them in the

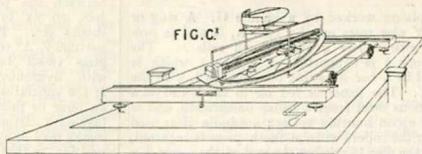

other. The compass needle is provided at the north pole with a small fork of platinum, which, as the needle gyrates, comes in contact with light tempered springs and makes the circuit through one or the other of the electromagnets 7, 8; the springs are carried by a small metallic ring placed round the race of the needle. Each time a contact is made the ring drops momentarily in order that the needle may continue its movement. Another electromagnet placed on the disc 16 keeps the

pencil in contact with the paper while the parts are in motion, but releases it directly the movement ceases. The board carrying the paper is supported on two bars A, B, and may be moved along them

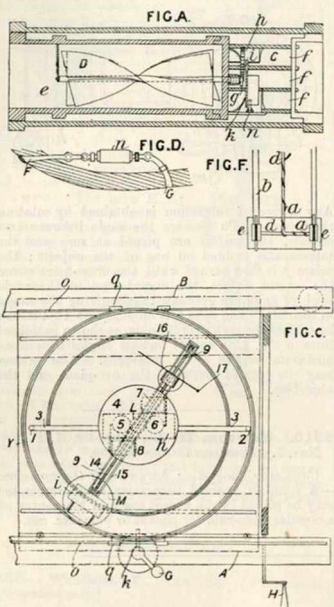

by a pinion worked by a handle G. A ring or circle Y also rests on the bars A, B, and is provided with rollers *q* running on rails *o*. The clockwork *h* is supported on a disc 4 which is secured to a bar 3 resting on supports 1, 2 on the ring Y. The paper is fed on to the board in a continuous sheet from a roller underneath, and is wound up on another roller; a handle H is used to turn the rollers when a fresh piece is required. When the disc 16 reaches the end of the screw 9, a screw *k* is tightened to fix the position of the parts, and the tracing pencil is raised in order to move the disc 16 to the opposite end of the bars 14, 15. The handle H is then turned to feed a fresh portion of paper on to the board, and the ring Y is adjusted until the pencil touches the last point plotted; the screw *k* is now loosened and the apparatus is in full working order. On reaching either end of the screw 9, the disc 16 makes contact with two springs, thus completing a circuit which contains a bell for giving a signal. The log is fitted inside or

on the outside of the vessel. It consists of a number of screw blades D, Fig. A, fitted inside a casing into which the water flows through the inlet *e* and passes away through three tubes *f*. An additional casing is used if the log is fitted outside the vessel. The back end of the screw shaft terminates in a chamber C and is provided with a projection *g*, which, at every revolution, advances the wheel *h* one tooth. A projection *i* on the wheel *h* drives the wheel *k* in a similar manner. The wheel *k* is also provided with a projection, which makes contact with a spring *n* at each revolution of the wheel and thus completes a circuit through two wires passing to the plotting apparatus; or if the plotting apparatus is not used, the wires may lead to a simple indicator marking on a series of dials or printing on paper the knots and fraction of a knot. Fig. D shows the log fitted inside the vessel. The water then enters the casing through a pipe F protected by wire netting and flows away through the pipe G. The conducting-wires are shown at *n*. When fitted outside the vessel, the log is raised and lowered on two rails *b*, Fig. F. A flat bar *d* supports the conducting-wires *a*, and is fixed into the bolts *e* which maintain the log in a horizontal position.

4371. Wirth, F., [Nolten, G.]. Nov. 11.

Clinometers; compasses, magnetic.—Relates to apparatus for measuring the deviation of a bore hole from the perpendicular and its bearing by compass. The indicating-apparatus is contained in an airtight and watertight brass cylinder lowered into the hole at the end of the boring-rod. The cylinder has rounded ends, and the rubber washers placed between the parts project, so as to prevent shocks &c. The compartment A contains a glass vessel half filled with hydrofluoric acid. If the apparatus is left in the bore hole for a half an hour or more, the acid etches away the glass, leaving a distinct ridge or shoulder. Horizontal marks may be etched with the glass in a horizontal position, so that the tilt can be measured. A vertical line on the glass and a notch in the bore enable the glass to be set in a fixed position with regard to the compass. The compass is placed in the middle compartment B and the watch in the uppermost compartment A. An arbor of the watch is prolonged and a brass plate is adjustably connected with it so that after a predetermined period of time it displaces a vertical lever. The movement of the vertical lever releases a spring, which rises and secures the compass needle at the point at which it is standing. A pencil is arranged

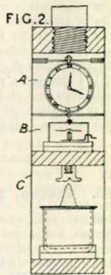

to draw a line on a piece of paper, to indicate that the release of the spring is due to the movement of the plate; if the spring is disengaged accidentally by a shock, the paper is not marked.

4473. Syré, A. Nov. 18.

Range-finders for military and other operations. Two telescopes F, F' are mounted on brackets L, L' at the ends of a tubular frame R, R' which forms the fixed base. The telescope F' is fixed, while F is mounted on a pivot b so that it can be adjusted by a screw a' to make the telescopes parallel, the perfect parallelism of the telescopes being observed by means of two small collimation telescopes V, V' placed at right-angles to the telescopes F, F' . The frame R, R' is fitted with rings M, M' and carried in the U-shaped ends U, U' of a bracket B, B' mounted to turn on a pivot A working in a socket formed on a disc T secured by T-headed bolts and nuts d, d' to the head e' of the tripod stand e, e' . A ring D embraces the disc T and has a projecting arm D' , the end z of which works in a slot in the end of the bracket B and is acted on by a spring G and screw E for turning the bracket to train the telescope on the object. The tripod legs e are held in position between jointed or pivoted arms f provided with tightening screws g . The telescope F is provided with cross hairs, while the telescope F' is provided with an adjustable vertical hair the motion of which is calculated by means of a micrometer screw m , the complete revolutions of which are recorded on a scale visible in the optical field of the telescope, the tenths &c. being indicated on the graduated drum t . To measure a distance, the telescopes are arranged exactly parallel to each other by means of the screw a' and the small collimation telescopes V, V' , and the telescope F is trained on the object; the vertical wire of the telescope F' is then moved by the micrometer screw m until it is exactly upon the object, when the scale is read off and the distance obtained by means of a prepared table. Fig. 9 shows a diagram illustrating the method of ascertaining the distance of a point N . The base O, o of the triangle o, N, O is known, the angle N, o, O is a right-angle, and the angle o, O, N is measured by the instrument, from which data the distance of N can be calculated or ascertained from the prepared tables.

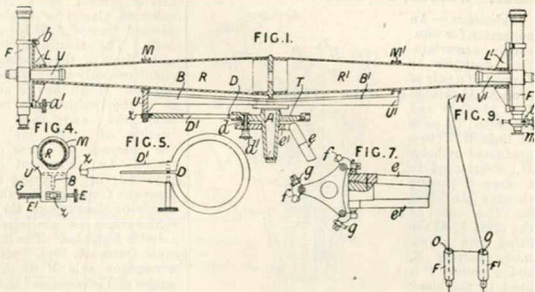

4816. Blamires, T. H. Dec. 13.

Thermometers; expansion, coefficients of, determining.—An annular vessel A is filled with liquid which is continuous with that in a tube B terminating in a cap closed by a diaphragm. A piston K rests upon the diaphragm and communicates its motion under heat or cold by rack and pinion gear to a dial as shown. The apparatus may be used as a thermometer or for determining the expansion and contraction of liquids.

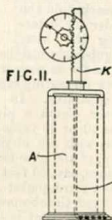

4865. Ettlinger, J. Dec. 16. [Provisional protection only.]

Graphoscopes.—A frame or frames containing a magnifying glass or magnifying glasses is or are fixed to the outer ends of telescopic tubes attached at right-angles to the external surface of the lower portion of each of the upright side-bars of an easel, and a movable tray or board for supporting pictures, prints, photographs, or drawings, or for supporting albums, portfolios, or books containing the pictures &c. is placed transversely across the telescopic tubes. The glasses, which are in a plane parallel to the surface of the picture &c. to be viewed, are focussed by elongating or compressing the telescopic tubes. One of the sides of the portfolio, album, or book may be fitted with a

magnifying-glass or magnifying-glasses for viewing the pictures &c. instead of fixing the glass or glasses on a separate frame.

4869. Weldon, F. Dec. 16.

Telemeters.—An apparatus for measuring or ascertaining distances is formed of a pair of arms A, A' pivoted to a block B and connected by pairs of links E, E' to a graduated cylinder H, K attached to a screw S passing through the block B. The ends of the arms A, A' are fitted with adjustable mirrors R, and a pointer P is fixed to the block B for indicating on a spiral scale on the cylinder K. A scale of yards is also marked on the cylinder for determining the base.

A right-angle can be obtained by extending the arms as far as they will go. Three pickets and a 60-foot measuring tape are required for use with the apparatus. In using the instrument, the observer plants a picket at p , Fig. 6, and then moves 40 or 50 yards and plants a second picket p' in line with the object x and so as to cause the lines p, p' and p', x to be at right-angles; he then measures, say, 60 feet along the line p', x to p'' and plants a third picket. These three points having been fixed, the observer moves 100 yards along p', p to D, which point is determined by observing that the reflected image of the picket p'' exactly coincides with the picket p' . The observer now faces the object x and turns the cylinder K until the pickets p, p' are both together reflected on the object x , when the distance is read off from the spiral scale. The scale may be graduated on a movable concentric cylinder adjustable to any length of base, and the apparatus may be furnished with a telescope.

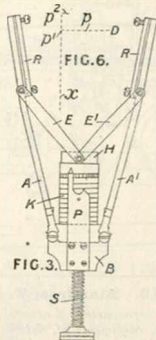

between mirror and lens to be reduced to a minimum. Figs. 1 and 3 (Sheet 1) show an arrangement in which the axis a of the mirror C is placed above the plane of the lens D which is contained in the inclined tubular leg G. The bearings of the axis a are formed of angular recesses having two sides at right-angles, into which recesses the axis is pressed by a spring x , Fig. 5°. Dark coloured glasses or shades E, F are carried in pivoted frames A, B for obscuring an overbright body. The azimuth mirror may be duplicated so as to allow of the bearings of two objects being simultaneously taken whose azimuths differ by 180 degrees. It can thus be ascertained when the ship is in the line between two lighthouses or other landmarks, and from the known magnetic bearing of this line and the reading of the compass, the error of the compass can be found. An instrument called a "deflector" is provided for measuring the horizontal directive magnetic force on board ship, from which measurements or observations the semicircular and quadrantal errors are ascertained by the application of suitable formulæ. The instrument consists of two cross frames A, Figs. 6 and 7 (Sheet 1), pivoted on a common axle B which slides between vertical guides and is connected to the H-shaped base frame D' by rubber bands I. The lower ends of the frames carry four magnets and the upper ends carry swivelled nuts D engaging a right and left handed screw C having a central graduated disc, by means of which screw the position of the magnets may be varied. When in use, the instrument is mounted on a pivot y on the compass bowl, which pivot, together with two feet y' , form three points of support. When the compass is placed symmetrically with respect to the ship's iron, the ship's head is put successively on the four cardinal points of the compass and the deflector is adjusted so as to depress the North point through an angle of 85°; when the four readings do not agree, there will be either quadrantal or semicircular error, or both, which is corrected by adjusting the fore-and-aft, thwartship, or revolving correctors or soft-iron globe of the compass. When the compass is otherwise placed, other methods of applying the deflector are used, different bearings of the ship's head being obtained which give maximum and minimum directive force of the ship's magnetism. Magnets of different strength may be used in place of the deflector; they are mounted so as to be free to move round a vertical axis. A dipping needle is used for measuring the vertical component of the ship's magnetic force, which needle is mounted so that the force tending to make it dip is measured by the torsion of a stretched wire. The needle G, Fig. 11 (Sheet 1), is carried by a wire F attached at one end to a spring H and at the other to a micrometer torsion head I. The needle is supported in a case A mounted on gimbals and having a compass card with its circumference divided into degrees fixed on the bottom. For the purpose of reading off the ratio of the vertical component of the ship's magnetic force, a vertical glass scale J, Fig. 12 (Sheet 1), is carried within the casing A, which is read by means of a wedge-shaped lens K, Fig. 12°. When the instrument is to be used, it is mounted in the binnacle in place

4876. Thomson, Sir W. Dec. 18.

Compasses, magnetic; bearings, instruments for determining.—Relates to mariners' compasses and to appliances for ascertaining and correcting errors in the same, and consists, partly, in improvements in the compass and appliances described in Specification No. 1339, A.D. 1876. In the instrument for taking azimuths, the axis of the mirror may be placed above or below the plane of the lens, to allow of the interval of no vision

of the compass; it may be turned round the gimbals to bring the stretched wire vertical, when it may be used for measuring or comparing horizontal components of magnetic force.

The Provisional Specification describes a method in which a glass rod attached to the centre of the stretched wire is balanced and projected far enough to reach to the cross-bar between the

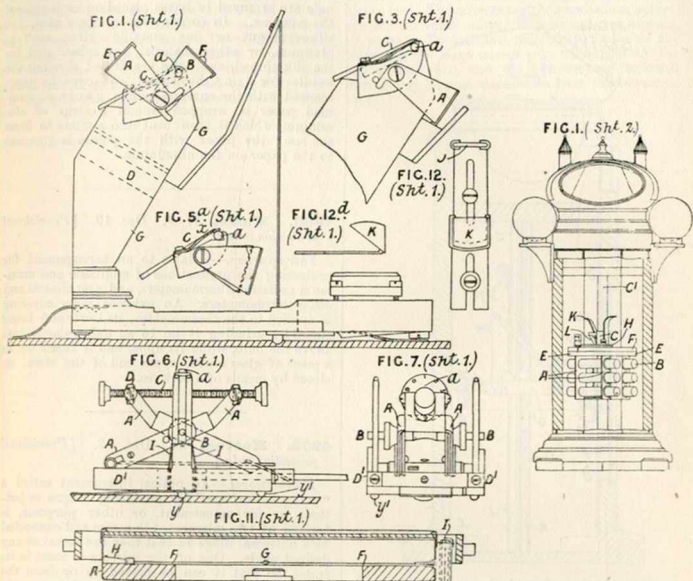

magnets. The semicircular error of the compass is corrected by means of two sets of magnets G¹ and A, B placed fore-and-aft and thwartship. The magnets are formed of steel wires tempered glass hard and soldered in brass tubes, a collar near one end marking the true South pole. One of the thwartship magnets B, Fig. 13 (Sheet 1), may be fixed in the cradle C or in the cradle x, while the other A is carried by a geometrical slide D and can be adjusted vertically, and fixed at any height as indicated by the scale F. The slide can be moved by a hook D¹ having a pin a for engaging holes in a plate b. Four thwartship magnets are used, two of which may be placed in cradles either at the side or bottom of the binnacle while the other two G¹ are carried by cradles H attached to a block P capable of sliding vertically on a post J, provided with a scale, as shown. The divisions on both the scales F and J are made from calculation or experiment, each division indicating the same amount of force, the width consequently increasing as the scale is read

in a downward direction. For correcting the heeling error, a magnet capable of adjustment is placed in a central vertical tube K. The magnet is enclosed in a brass case having feet bearing against the inside of the tube; it is adjusted by a nut Q on a set-screw sliding in a slot. An alternative arrangement, consisting of a method of continuous magnetic adjustment as described in Specification No. 329, A.D. 1858, [Abridgment Class Electricity, Measuring &c.], may be used. A cradle A, Fig. 1 (Sheet 2), for carrying three pairs of magnets B, is fixed to a tube C sliding and turning on a central tube K containing the heeling-error magnet. A disc E attached to the cradle A is provided with a scale of degrees for showing the angular position of the magnets, and to facilitate adjustment of the compass for any course of the ship, an auxiliary or guide circle F is mounted on the circle E and provided with two scales, one showing degrees and the other showing 131.7 times the logarithmic co-secants of the corresponding angles. A vertical scale is placed in the sid-

of the binnacle graduated to show the force exerted on the needles by the corrector. This scale is graduated so that when the force of the corrector is perpendicular to the direction of the needles,

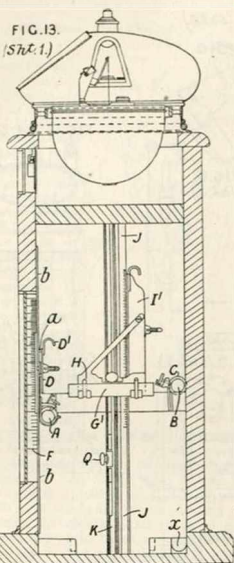

the raising or lowering of the corrector through one division of the scales causes the compass card to be deflected through the same angle as it would be by turning the corrector through one degree when the ship is so placed that the force of the corrector is approximately in the direction of the needles. The circle E has a rim over which extends an adjustable arm H attached to the collar C, and having its outer end sliding between guides on the binnacle, thus enabling the slide A to move vertically but to be fixed against rotation. A lever K, acted on by a spring L, is provided with a pin for engaging any one of a vertical series of holes in the tube C'. The heeling-error magnet is moved by means of a chain or cord. A screw may be cut on the tube C' to carry a long nut on which is a second collar carrying the cradle. To correct the quadrantal error when the ship's iron is not symmetrical, iron masses or balls are arranged so that they may be turned round in azimuth or moved inwards or outwards and clamped in position. The binnacle may be turned in azimuth before fixing it, so that the line joining the centres of the globes is in the

proper position for correcting the quadrantal error, or the top of the binnacle carrying the iron globes is arranged to turn to bring the globes into any required position. When there is not room for a binnacle, transverse and longitudinal correcting magnets are arranged in boxes placed on each side of the compass. In forming the compass card, fine silkworm gut or fine metallic wires, such as platinum, or other material, are substituted for the silk thread, and holes are drilled through the needles for fixing the wires. To secure the paper marked with the compass points, a strip of gummed paper is wrapped around a strip of aluminium, which is then bent into a circle to form the rim; the paper with the points is gummed to the paper on the aluminium.

4900. Hicks, J. J. Dec. 19. [Provisional protection only.]

Thermometers.—Relates to an arrangement for protecting the graduations of minimum and maximum radiation thermometers, and also clinical and other thermometers. An exterior glass covering is applied to the thermometer, its lower end being closed by grinding it on to an enlargement just above the bulb, while its upper end is fused on to a piece of glass on the upper end of the stem, or closed by means of a cork &c.

4906. Hatton, E. Dec. 19. [Provisional protection only.]

Kaleidoscopes.—An optical instrument called a "polygonous-scope," for producing designs or patterns, or for amusement, or other purposes, is formed of two mirrors set in a case and connected by a universal hinge so that they can be set at any desired angle. One of the mirrors is loose in its frame, so that it can be moved to or from the other to cause the edges of the mirrors to be always in contact when inclined at any angle. The "hinge for connecting the frames of the mirrors" consists of three joints, that is to say, one joint "for each frame, and a centre joint on which the "other two hinge. By this means the frames can "be opened to the full extent, and turned back "to any angle, and they can be folded close "together."

4933. Place, J. Dec. 21. [Provisional protection only.]

Magic-lanterns, slides for. The rack, lever, and other rings and mechanical work for magic-lantern slides are made in one piece from sheet brass or other metal by the processes of stamping or spinning, instead of by the usual method of making them from castings or drawn metals.

4955. **Lake, W. R.**, [*Fritsch, C.*, and *Forster, J.*]. Dec. 22. [*Provisional protection only.*]

Telescopes.—A telescopic tube with a lens sliding in another tube is combined with two mirrors fixed outside the telescopic tube in order to form a telescope. The larger concave mirror is arranged on the outside of the telescopic tube, and the smaller mirror is attached at the end of a rod in a line with the axis of the telescopic tube and

lens in such a manner that the image of a distant object is reflected from the larger mirror to the smaller mirror which again reflects it into the telescopic tube so that the image can be viewed by the lens. The mirrors may be parabolic or spherical, and the small mirror may be concave, convex, or plane. To facilitate the transportation of the telescope, the large mirror may be hinged to the top of the tube, and the rod carrying the small mirror may be made detachable from the telescopic tube.



The SUBJECT-MATTER INDEX of SPECIFICATIONS of PATENTS, dated A.D. 1902, is now on Sale, price Two Shillings per copy. By parcels post Two Shillings and Fourpence.

ABRIDGMENTS OF SPECIFICATIONS IN CLASSES.—The 146 volumes for each of the periods 1855-66 and 1867-76 are in preparation, and the sheets already printed can be seen in the Patent Office Library and in some of the principal provincial libraries. The volumes can be obtained sheet by sheet, as printed, by payment in advance of a subscription of 2s. for each volume, including inland postage. Sheets have been printed for all Classes for 1867-76, and in some cases the volumes have been published.

PATENTS RULES, 1903.

The Patent Rules, 1903, are now on sale, price 6*d.*, by post 7*d.* All general Rules relative to Patents heretofore made by the Board of Trade under the Patents, Designs, and Trade Marks Acts, 1883-1901, and in force on the 12th day of January, 1903, are repealed as from that date.

THE READING ROOMS of the FREE PUBLIC LIBRARY OF THE PATENT OFFICE are open daily from 10 a.m. till 10 p.m., except on Sundays, Good Friday, Christmas Day, and Bank Holidays. On Christmas Eve, Easter Eve, Whitsun Eve, and the day appointed to be kept as the King's birthday, the Library is closed at 4 p.m.

